

CIGR

Design Recommendations of Beef Cattle Housing

**Report of the CIGR Section II,
Working Group No. 14
Cattle Housing**

2nd edition
September 2004

East Lansing, Michigan, USA

Impressum

Herausgeber

Bundesanstalt für alpenländische Landwirtschaft Gumpenstein, A-8952 Irdning, des
Bundesministeriums für Land- und Forstwirtschaft, Umwelt- und Wasserwirtschaft, Wien

Direktor

HR Dipl.Ing. Dr. Kurt CHYTIL

für den Inhalt verantwortlich

die AUTOREN

Redaktion

Brigitta KRIMBERGER und Ingrid ZAINER

Druck, Verlag und © 2003

Bundesanstalt für alpenländische Landwirtschaft Gumpenstein, A-8952 Irdning
ISSN 1026-6275
ISBN 3-901980-58-x

Internet

<http://www.bal.bmlfuw.gv.at>

Dieser Tagungsband wurde vom Bundesministerium für Land- und Forstwirtschaft,
Umwelt- und Wasserwirtschaft finanziert.

Contents

Preface	V
Chapter 1, Overview of Production Systems	9
Chapter 2, Designing Facilities to Meet Animal Needs	13
Chapter 3, Animals, Buildings and Equipment Dimensions	17
Chapter 4, Floors and Walking Surfaces	21
Chapter 5, Facilities for Feeding and Drinking	25
Chapter 6, Ventilation (Environmental Control) of Livestock Barns	29
Chapter 7, Sukler Cows and Calves	33
Chapter 8, Housing for Calves from Birth to 6 Months	39
Chapter 9, Housing for Finishing Animals	43
Chapter 10, Safety and Animal Handling	47
References	53

Preface

Many people are involved in the design and specification of beef cattle housing: - engineers, architects, extension services, building contractors, and finally the facility manager himself. To achieve a high satisfaction level it is necessary to take into account a range of different factors when defining the optimum animal house for a specific situation. These factors include - animal productivity targets, animal behaviour, animal needs, animal dimensions, climate, labour availability, manager preferences, animals handling and personnel safety.

The scientific literature is comprehensive and reports research that has been capped out in different countries and with different beef cattle breeds. This report takes into account the data of the scientific literature and the practical experience of respected specialists involved in the practical design, construction and management of beef cattle housing in Europe and North America.

An attempt has been made to provide the busy professional designer and manager with an understanding of the underlying principles that form a basis for engineering and construction solutions.

The authors of this report come from ten countries, some near, some far. They met on five occasions and communicated very intensively by e-mail to find the best solutions to house beef cattle and to present the results of their discussions and works. In front of you, you have the very successful result of their work. Please let it know to all the interested persons in the beef cattle industry.

It is a privilege to have been appointed first as member and later as chairman of this working group. I thank all the group members for their original contributions and the enthusiasm they have given to this ambitious project.

Josi Flaba

September 2002

Others who contributed to this report are :

Jeff Owen, the former Chairman, Farm Building Research Team, ADAS Reading, Coley Park, Reading RG1 6DE, UK;

Prof. Dr. Helmut Bartussek, Bundesanstalt für Alpenländische Landwirtschaft Gumpenstein, A-8952 Irdning, Austria;

Prof. Umberto Chiappini, Università degli Studi di Bologna, Istituto di Edilizia Zootecnica, Via F.lli Rosselli 107, I-42100 Reggio Emilia, Italy;

Dr. Heinrich Pirkelmann, Bayerische Landesanstalt für Tierzucht, Prof. Dürnwächter Platz 1, D-85586 Poing, Germany;

Michel Smits, Institute of Agricultural and Environmental Engineering (IMAG - DLO), Mansholtlaan 10-12, PO Box 43, NL-6700 AA Wageningen, The Netherlands
former members of the CIGR Section II Working Group No 14, Cattle Housing.

Mrs. Colette Trousselier, Institut de l'Élevage, 5 rue Herman Frenkel, F-69364 Lyon Cedex 07, France, needs a special mention for all the work she put into compiling the figures.

Sonja Keiblinger, Brigitta Krimberger, E. Finotti and Ingrid Zainer, Federal Research Institute for Agriculture in Alpine Regions Gumpenstein, A-8952 Irdning, Austria, also need special mention for all the work they put into drawings and formatting the text.

COMPOSITION OF CIGR WORKING GROUP ON CATTLE HOUSING

Josi FLABA (Chairman) Ingénieur-directeur
Ministère des Classes moyennes et de l'Agriculture
Service Développement Production animale, WTC 3, 20^{ème} étage
Boulevard Simon Bolivar 30, 1000 Bruxelles, Belgium

Professor **Bill BICKERT**
Department of Agricultural Engineering
Michigan State University East Lansing, 48824-1323 Michigan, USA

Jacques CAPDEVILLE
Institut de l'Élevage, BP 18, 31321 CASTANET TOLOSAN Cedex , France

Dr. **Heiko GEORG**
Federal Agricultural Research Centre (FAL)
Institute of Production Engineering and Building Research
Bundesallee 50, D-38116 Braunschweig, Germany

Ir. **Robert KAUFMANN**
Swiss Research Institute for Agricultural Economics and Engineering
CH-8356 Tänikon, Switzerland

Ir. **J.J. LENEHAN**
Teagasc Grange, Research Centre
Dunsany Co. Meath, Ireland

Ir. **Jim LOYNES**
Head of Engineering, School of Agriculture
Harper Adams University College
TF10 8NB Newport, Shropshire, England

Dipl. Ing. **Alfred PÖLLINGER**
Bundesanstalt für Alpenländische Landwirtschaft in Gumpenstein
A-8952 Irdning, Austria

Michel TILLIE
Association Française du Génie Rural
6 rue Pasteur, F-62217 Beaurains, France

Dr. **Michael VENTORP**
Swedish University of Agricultural Sciences
P.O. Box 59, S-23053 Alnarp, Sweden

Professor **Paolo ZAPPAVIGNA**
Universita Degli Studi di Bologna, Sez. Ingegneria
Via F. Illi Rosselli 107, I-42100 Reggio Emilia, Italy

Chapter 1

Overview of Production Systems

1.1 Introduction

Each production system - veal calf, suckling calf, dairy bred calf, steer and heifer - implies different rearing, management and housing systems. According to the end purpose, the calves will be reared with their destination in mind. For the different systems the rearing period and the corresponding feeding system will be extended over a shorter or a longer period depending on productivity targets. Each enterprise may require a specific type of housing and, in some cases, rules are imposed for animal comfort as in the situation of organic production systems.

1.2 Categories of Production Systems

Veal calves

Feeding: based on whole milk or milk replacer.

Housing: individual pen or collective pens (with automatic milk feeder)

Slaughtered when they reach about 110 to 250 kg

Suckling calves

Feeding: natural suckling, complemented with concentrates (when grazing and indoors) if they are to grow to adult age (see steers)

Housing: with their mothers in cubicles or others loose housing

Reared to become replacement animals or to be fattened.

Slaughtered at about 200 - 250 kg

Bull calves

Reared in groups until weaned.

Feeding: milk replacer automatically or manually distributed

Housing: group housing

Slaughtered at about 11 to 15 months

Bull beef

First period: See bull calves.

Second period: Fattened until they are slaughtered

Feeding: silage and concentrates from troughs

Housing: usually in small groups (no more than 20 animals per group)

Slaughtered at about 18 months

Steers

Castrated animals, from suckling calves or dairy bred calves

First period: fed on their mothers' milk or artificial milk, then gradually turned to concentrates and forages.

Housing: with their mothers

Second period: after the weaning and castration, fed on grass and kept out doors

Third period (finishing): fed on concentrates and usually housed in free stalls.

Slaughtered between 24 and 30 months.

Heifers

Heifers are reared along the same pattern as bull calves or steers.

Cull cows

Cull cows may be fattened after when milk production ceases on the same pattern as steers.

Suckler cows

Although not directly reared for beef, suckler cows are an essential link along the production line and hold a very important role in the production system. The quality of the animals produced depends on the quality of the suckler herd.

Feeding: grass and some concentrates if necessary during the summertime; silage, hay and concentrates during the wintertime.

Housing: outdoors in the summertime; indoors, inside the barns (loose housing) in the wintertime.

Figure 1-1 shows the characteristics of each production system.

1.3 Housing Facilities Required for Good Management

In beef production, the calf remains with its mother from birth until weaning, which may occur at the age of 2 to 6 weeks or at the age of 2 to 6 months, and sometimes more. During the time with its mother, the calf is fed by its mother and has the opportunity to eat concentrates, hay or forages. In dairy production (and sometimes in beef production), weaning may occur at birth or just a few

hours after birth (10 to 36 hours). The new-born calf receives colostrum, then milk for a few days or weeks, and then milk replacer. In beef production this occurs mainly in the double muscled breeds in order to decrease mortality at a very young age.

1.3.1 Period from 0 to 6 months: calves weaned at birth

At birth, the calf has no immunity against the infectious germs living in the environment. It will be immunized passively by the mother's colostrum. Afterwards, the calf will progressively build its own immunity by contact with the germs (infectious and non-infectious) of the environment.

The new-born can be separated from its mother and other animals immediately after the birth in order to avoid a contamination with infectious germs, which are generally passed on from older animals to younger ones. The calf should be housed lonely so as to avoid any possible contact with contagious animals that might contaminate it.

Individual hutches placed outdoors make it possible to remove the calf from the other animals in the first minutes after birth. Besides, it is recommended to take the calf outdoors as soon as it is dry and it has received colostrum.

The new-born calf may stay with its mother for 1 to 3 days to give him the opportunity to build relationship with its mother. The hygiene of the pen and the provision of colostrum immediately after the birth are of great importance to protect the health of the new-born calf.

The calves must be kept in accordance with regional regulation of animal welfare.

Provision of colostrum: As soon as possible after birth the calf should be given colostrum with the aim of acquiring immediate protection against various infectious diseases and to be assured the calf has received the recommended amount.

Provision of milk: Milk or milk replacer can be distributed manually or by automatic milk feeder. In this case, calves are brought together within a period of



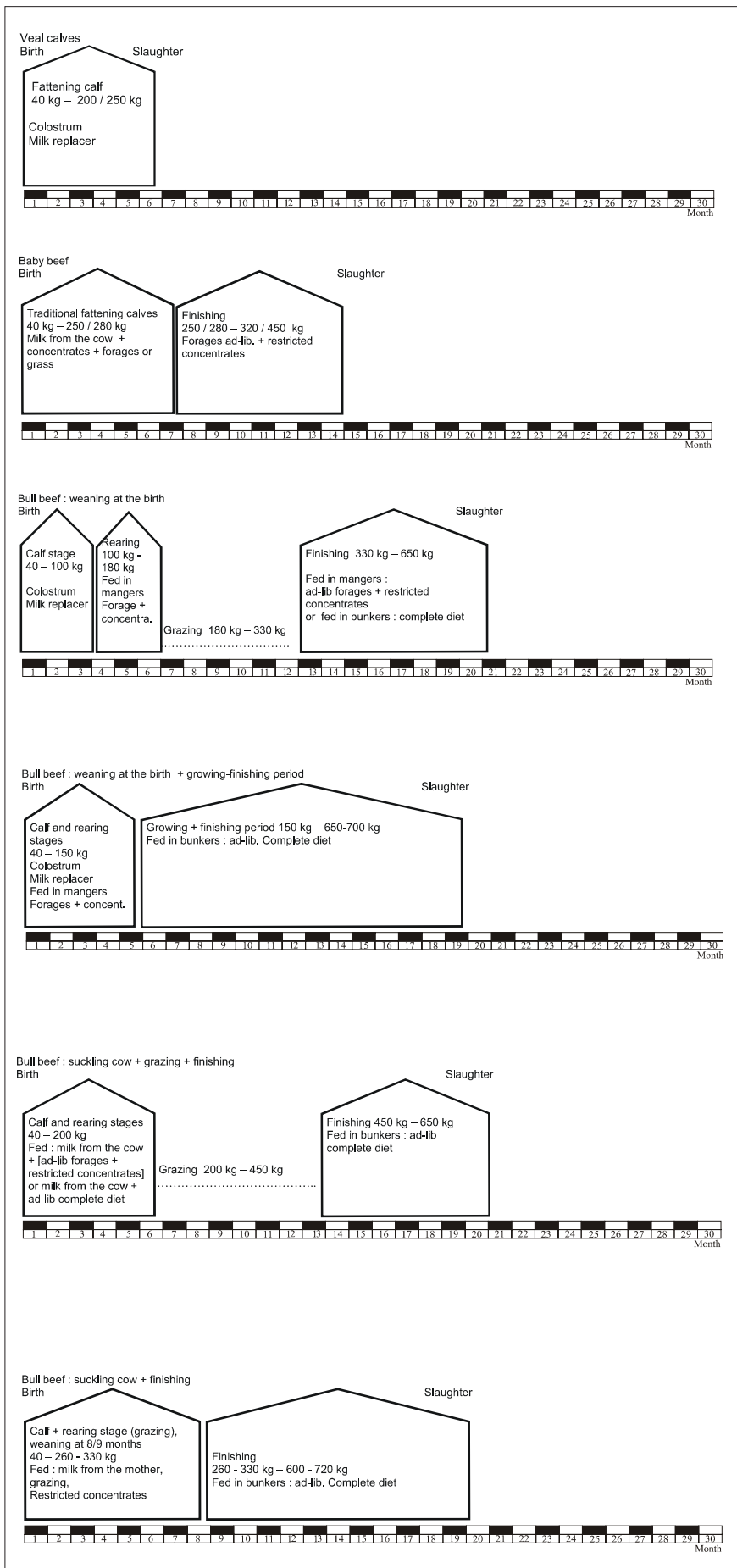

3 to 4 weeks to have 20 to 30 calves per group or pen. The amounts of distributed milk may be adjusted to the particular needs of any calf.

Housing in individual pens:

During the period that calves are fed on milk (whole milk or milk replacer), which lasts for about 2 months, it is preferable to adopt single housing so that feed consumption may be checked (both milk and dry feeds such as cereals, concentrates, ...). The optimal weaning time may be fixed but delayed if necessary when it appears that the calf does not eat the amount of concentrates required to satisfy its needs when milk is no longer supplied.

An obligation of the EU is to bring animals into physical contact with their equals. In non-EU countries, the regulation of animal welfare must be taken into account.

To prevent spreading of diseases, it is recommended to limit the number of calves having physical contacts to two or three. Physical contacts give the opportunity for calves to suckle ears, navels and teats, which may lead to deformations and sometimes even cause infections.

Group housing:

Housing several calves (8 - 10) together might only be considered if the animals are of the same size. Calves can be housed in groups from the age of one week with appropriate management to reduce the negative effect of competition.

Dehorning:

To prevent accidents with the persons involved in animal care and animal handling and injuries to the other animals, it is recommended to dehorn the animals at a very young age by burning with a proprietary heating element by specially trained staff. Local anaesthesia may be required by legislation in specific countries.

Cleaning and disinfection:

Between successive uses, it is absolutely necessary to clean and disinfect the pens or the hutches. Moreover, it is highly recommended to let the pen or the hutch remain empty for about two weeks for health reasons.

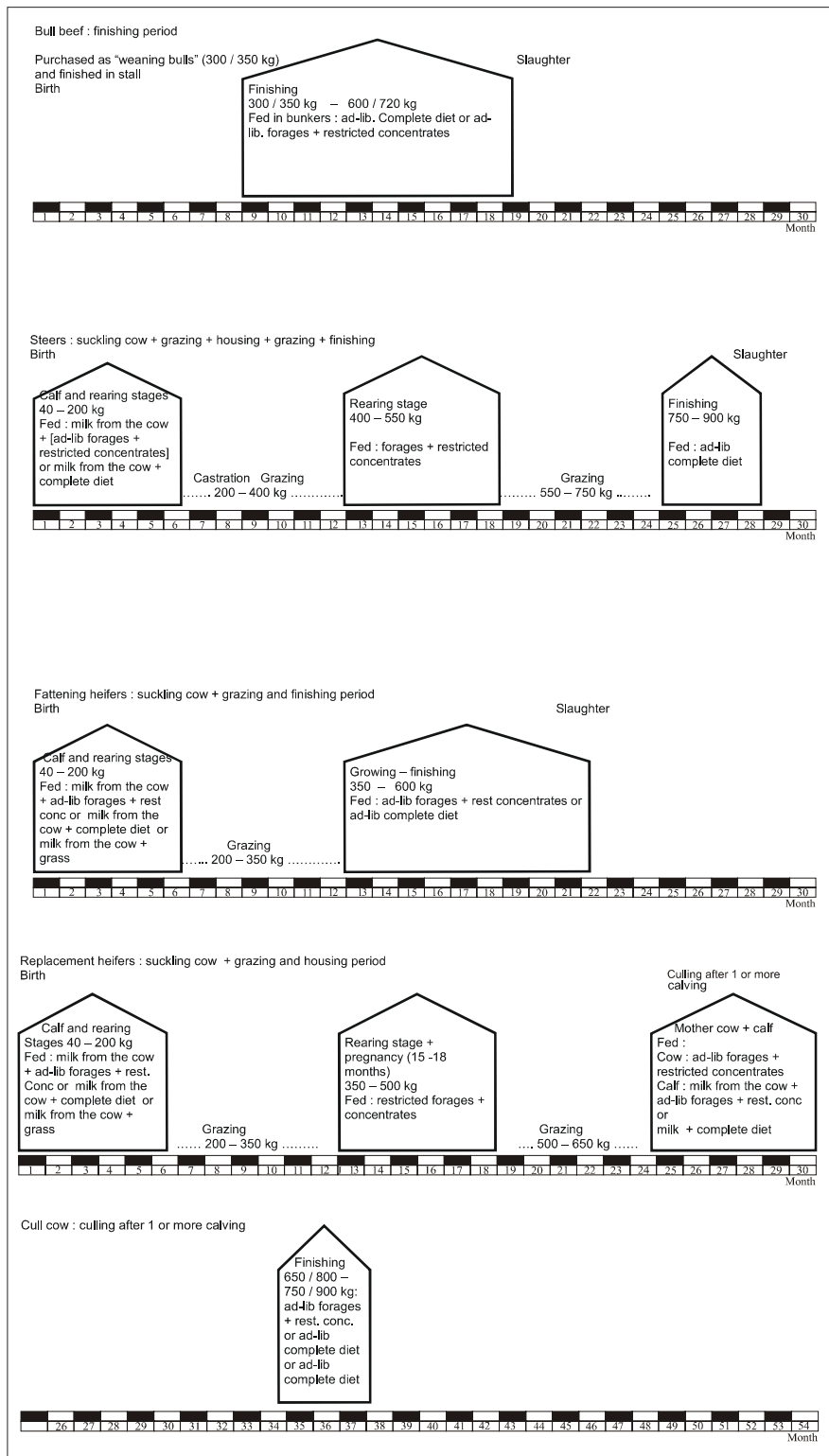

Figure 1-1: Schematic representation of the different categories of production systems

1.3.2 Period from 0 to 6 months: calves remaining with their mothers

Calving:

It is highly recommended to let the cow calve alone in a pen with enough surface and bedding material (fresh straw of good

quality, ...) but close to her herd mates to prevent stress.

Provision of colostrum:

Normally the new-born calf nurses within a short time after birth. But the calf may not drink enough colostrum to re-

ceive a strong protection against infectious diseases. It is advisable, especially when the calf is weak or calving has been difficult, to give the calf additional colostrum as soon as possible after the birth.

1.3.3 Fattening animals

Unusual behaviour:

There is a real social order among male uncastrated animals. In feed lot systems, the consequences will be controlled through providing a large area and limiting the number of animals in that area. On the other hand, aggressive behavior is likely to occur with small groups. Thus, it is necessary to:

- Check regularly that no animal is kept away from the group. It may become necessary to remove a weak animal.
- Dehorn all the animals.
- Provide sufficient area.

Grouping strategies:

- Groups should be formed after watching the behaviour of the animals during first stage of the rearing.
- Groups should be homogeneous in terms of weight and height at the withers of the animals and behaviour to avoid possible accidents, especially since mounting is impossible to avoid in that type of production.

Sufficient area:

Whatever the type of animal, minimum areas should be provided. When animal density exceeds recommended standards, diseases and injuries are likely to occur.

A healthy environment:

Disease hazards remain high and environment standards should strictly be respected to reduce possible infections.

Treatment against the external parasites:

When the animals enter the barns for fattening or winter time, it is recommended to treat them against the external parasites living in their hair. To improve the effectiveness of chemicals used to destroy parasites it can be useful to shave the animals to remove long hair. If the barn is inadequately ventilated, removing the hair will help the animals regulating their body temperature.

Chapter 2

Designing Facilities to Meet Animal Needs

2.1 Introduction

At present, it is generally agreed that the basic requirements for welfare of live-stock are :

1. The provision of readily accessible fresh water and nutritionally adequate food as required;
2. Adequate freedom of movement and ability to stretch limbs;
3. Sufficient light for satisfactory inspection;
4. The rapid diagnosis and treatment of injury and disease;
5. Emergency provision in the event of a breakdown of essential mechanical equipment;
6. Flooring which neither harms nor causes undue strain;
7. The avoidance on unnecessary mutilation.

2.1.1 Behaviour

Over thirty years ago discussions about animal welfare led to basic rights for animals being formulated in the Brambell Report. This report recognised certain basic physical needs in relation to housing. These were the right of an animal to have sufficient freedom of movement to allow it to get up; lie down; groom normally; turn around; and stretch its limbs, without difficulty.

Since Brambell, much research has been done to clarify behavioural needs or goals. Work of relevance to the achievement of behavioural goals, which are fixed in the animal, deserves special mention. Animal motivation and the functional consequences of behavioural processes are the most important aspects, since they play an important role in evaluating animal welfare and predicting and controlling the underlying environmental conditions that influence behaviour.

Motivation

Cattle are highly motivated to rest, feed, drink and move around. However, the need for an animal to carry out a certain behaviour at a certain time is still not clear. In this context the model developed

by WIEPKEMA (1982) is relevant. According to this model, an animal always tries to proceed from the present situation (Existing value) to the goal (Required value). Only when the goal can be reached, the behaviour will end in an appropriate way and welfare will be assured.

Functional consequences

When an animal is motivated, it will perform one or more behaviour patterns. According to the HUGHES and DUNCAN (1988) model of foraging behaviour, proper functional consequences are the main reason for an animal ceasing the behaviour. Therefore, creating opportunities for appetite behaviour alone (one part of the total foraging process) is not enough. This simply strengthens the animal's motivation but does not allow the animal to achieve satiation. Even the presence of the means to achieve a behavioural goal is not always enough; since providing a food supply for even a short duration will also strengthen motivation. Only completing the whole cycle (in foraging this means allowing satiation to be achieved) leads to a longer term decrease of motivation.

Predictability and controllability

The predictability and controllability of environmental conditions should be included in any discussion about behavioural needs. They are of crucial importance in evaluating stress. Control of environment factors; e.g., those influencing social interactions and feeding times, should be optimal. The predictability of response to certain behaviour should be high and there should be opportunities for synchronisation to avoid frustration or competition.

Stress

This has to be at the correct level. Too little stress can be just as harmful as too much. Intelligent animals need a complex and changing environment just as much as they need predictability and controllability. Besides ethological and physiological disturbances, excessive stress

can also have negative effects on the animal's immune system and make animals more sensitive to infectious disease. Boredom can exactly have the same effect.

Housing submissive animals in a building with insufficient space can create a chronic stress, because they fear close contacts with dominant animals and undergoing severe aggressions from their herdmates. The climatic environment can cause stress since animals may have difficulties maintaining their body temperature. The unfriendly herdsman behaviour will enhance the animal fear and stress, especially if he comes too close to the animal.

2.1.2 Health

In many cases, concern about welfare is largely about the physical health of the animals and the economic consequences of their health. However, even if consideration is confined to the very limited issue of keeping the animals free from costly diseases, the situation will be far from simple. Disease is generally multifactorial and housing is only one of many factors involved. Furthermore, housing cannot be considered as a single factor, since a housing system can comprise a number of different designs and might include or exclude details that influence the incidence of a certain disease. What can be done is to find out how some detail is involved in the disease; e.g. how does the length of a stall or the area of the straw yard per animal affect contamination of the lying area and how does such contamination influence the incidence of mastitis within suckling cows. Even with such information one must be careful since a different stall design might well have features that would alter the desired length, or the incidence of mastitis might rely more on other factors (e.g., immune status, productivity or feeding) than on contamination of the lying area.

Consequently, predicting the consequence of all the details combined in any one housing system can only be speculative.

In the unnaturally dense populations of housed farm animals, the risk of infection will be high. To some extent, this



elevated risk can be counteracted by an increase in activity of the animals' immune systems. It is a question of getting the balance right. What is required is a level of infection that allows animals to develop immunity to disease, but not such a high level that it causes disease in animals with immunity. Non infectious contaminants, such as inert dust particles and ammonia gas, can also harm animals by causing damage to the respiratory defence mechanism. Such agents can make the animal less resistant to infection allergies.

In beef production, the facultative pathogens normally living in the air and causing respiratory diseases will become dangerous only, if they find favourable conditions: animal overcrowding, high air humidity, air with too many dust particles, draughts, excessively high air temperature, etc. To prevent diseases, it is advisable to limit the number of facultative pathogens living in the air because it is not possible to destroy them completely. Good ventilation and a favourable animal occupation density are two important measures to prevent respiratory diseases.

To prevent contagions within the herd it is recommended to isolate ill animals as soon as possible although it is difficult to have enough room or pens for them. The cohabitation of animals of various age and the bringing together of animals coming from different farms represent a situation with many risks. A quarantine practice (facilities + management) for purchased animals is advisable to diminish the risk of disease outbreak. Number of animals per pen should not be higher than 12 to prevent social pressure: submissive animals are frequently disturbed by dominant animals.

Control of microbe populations and comfortable housing are the two major points to preserve the beef cattle health.

2.2 Housing Systems

In many modern beef units animals are kept indoors all the year round. Therefore, it is important to ensure that, whatever housing system is provided, behavioural needs (e.g. resting, feeding and drinking) are properly met. In loose housing systems, the freedom of movement of the animals means that both

individual and group behaviours must be satisfied.

2.2.1 Resting

In loose housing systems cattle rest for many hours per day. Resting behaviour depends on various factors including times of feeding, feeding frequency and management. Resting time is divided into lying time without sleep and lying time with total muscle relaxation sleep. For the latter, the cattle should be able to lie down with its head resting on and supported by the shoulder, so that the neck muscles can relax. To avoid disturbance and ensure suitable opportunities for resting, enough space should be available for each animal.

Cattle spend about 50 % of their time lying, for about 10-15 periods per day, each of about 60-80 minutes duration. The duration of each lying period is influenced by the housing environment but total lying time seems to be fixed. An animal will not stay recumbent for too long before it becomes uncomfortable. This is because the large body weight of heavy animals causes high pressures to be imposed on those parts of the body that are in contact with the ground. Lying entirely on one side is only possible for about 10-15 minutes at a time. This is because the pressures exerted cause disturbances in pulmonary blood flow and the disposal of rumen gases.

For socially gregarious animals like beef cattle, synchronisation is important to their behaviour and competition in groups. To avoid competition in communal lying areas, there should be enough space for all animals to find a resting place and to lie down together. If cubicles are used there should be a cubicle for each animal. Increasing the floor space per animal in growing-finishing period from 2.0 to 4.2 sq m for example resulted in appreciably greater daily weight gain. As a consequence of insufficient lying area there may be an increase in aggression and/or disturbances of behavioural rhythms (eating and resting times). In addition, animals that are unable to lie down will spend significantly longer time standing and will have an increased lying requirement when they do lie down.

Animals lying on slatted floor may show abnormal standing and lying behaviour. Abnormal standing up and lying down

are caused primarily by factors associated with a hard floor.

2.2.2 Feeding

Cattle spend many hours per day eating. If the feed is fed restrictively, there should be sufficient feeding places for all animals to feed at the same time to avoid competition, frustration and aggression. Any restriction in number of places may result in low-ranking animals receiving insufficient feed and, as a consequence, their daily weight gain will be too low or they may lose excessive weight. If the feed is fed ad libitum and if there is one eating place per two or three animals, each animal will have enough time to eat all the feed it needs.

If roughage is fed ad libitum and concentrates restrictively, there should be sufficient feeding places to feed the concentrates to all animals at the same time.

2.2.3 Drinking

Drinkers should be located where they are easily accessible. They should not be located where it is impossible for submissive animals to leave when a dominant animal approaches, e.g. in corners or at the end of a passage. There should be enough room around the drinkers to avoid difficulties for animals to drink.

Care must be taken to ensure that the drinker will not be fouled with faeces or urine. When the straw is spread it is recommended to ensure it is not to throw it into the drinkers.

The cleanliness of the water and of the drinkers and the functioning of the drinkers should be checked every day. Good functioning of the drinkers is especially important for animals being fed a feed with a high dry matter content. Freezing of the drinkers should be prevented during the cold days, especially if animals receive dry feed.

2.2.4 Locomotion

Floors should not be slippery when beef cattle walk or move on them. Any slips that occur during, or as a result of, confrontations can bring the animals into a state of chronic stress. Slippery floors can also cause beef cattle to reduce their movement, grooming activities and mounting activities. Movement difficulties can cause irregular hoof wearing and lameness.

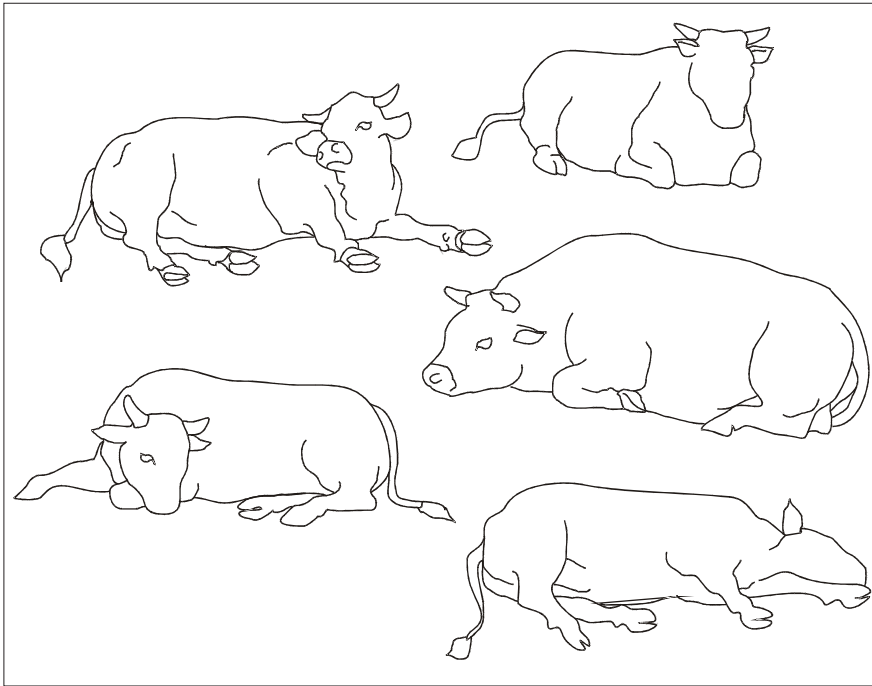

Figure 2-1: Natural lying positions (according to SCHNITZER, 1971)

2.2.5 Group size

In buildings the groups are made on basis of sex (no males with females except for reproductive purposes), age of animals (bulls of the same age and weight, calves or heifers of the same age and weight), reproductive purposes (mother cows with their calves with or without a bull), diet, future of the animals (fattening, breeding, ..), physiology status (pregnant cows, cull cows), ...

To prevent disturbances with fattening bulls (excitation, bellowing) and low growing performance it is recommended to house the bulls in a building without females.

To prevent aggressiveness and negative effects of hierarchy problems it is recommended to regroup animal of the same age in group of limited size (10 to 12 bulls in the same pen, 12 to 16 cows with their calves in the same pen, ...). If the calves are with their mother, it is necessary to have a separated pen accessible only to calves: calves should be able to move freely or during limited periods to their mother, not the opposite.

In practice, group size depends on management factors such as herd supervision and feeding. The formation by the farmer of smaller groups within a herd is usually based on factors such as age of the animals, weight, sex and diet.

2.2.6 Hygiene

Every effort should be made to prevent animals from becoming dirty. It is most important to keep the beef cattle lying area clean, which can be achieved by correct design and by sufficient use of bedding material. If animals are dirty, they will be uncomfortable, development of (ekto-)parasites in their coat could be increased, heat losses could be increased and their market value could be decreased.

The use of bedding and the frequency of cleaning and adding new bedding are important for the hygiene of the lying area.

Walking areas should also be kept reasonably dry and clean since any dirt picked up on the hoof will be deposited on the lying area and will soil the animal. In addition, dirty hind legs may be in contact with the udder when the suckling cow is lying. A dirty udder can cause suckling problems with the calves. Wet and dirty walking areas will also reduce the durability of the hoof horn and make the beef cattle susceptible to foot diseases.

2.2.7 Animal injuries

In loose housing two kinds of injuries are common: leg or claw injuries and other surface injuries. Floors have to be designed to prevent leg and claw injuries and to realise sufficient wear of the hoof to

avoid overgrowth of the hoof. It is important to trim the claws as often as necessary. Other surface injuries mainly result from aggressive behaviour, often aggravated by too little space being provided for submissive animals to escape and inadequate equipment design. Emphasis on adequate dimensioning of all areas and on optimal equipment is therefore essential.

Aggressive behaviour furthermore strongly depends on the quality of herd management, especially on the feeding regime and the ability of the herdsman. The dehorning of animals, especially of males, decreases the aggressiveness, decreases the consequences of aggressiveness and prevents animal injuries caused by the horns. Dehorning diminishes the danger for man during animal handling.

2.3 Environment and Health

2.3.1 Air quality and ventilation

In well ventilated barns the air generally is of good quality and is not the cause of respiratory diseases.

In livestock buildings, animals are densely stocked, floors may be covered with faeces and urine, underfloor slatted tanks may hold stored slurry and there can be large quantities of dusty feed and bedding. As a consequence the air in these buildings heavily can be contaminated with inorganic dust, spores, moulds, bacterial and viral organisms, gases, vapours and other pollutants. Airborne particles may cause infections, allergies and other responses while gases and vapours may be poisons, asphixiants, or irritants. These aerial pollutants may be very small or invisible and may not smell; indeed one may not know they exist. They are easily inhaled.

In cattle buildings, the most dramatic effect of air pollution is seen in young calves. These animals, with their immature immune systems, cannot resist the massive challenge of airborne infectious agents and serious respiratory problems are common. Adult animals are more resistant and able to tolerate such aerial contaminants. However, while adult animals seldom exhibit clinical symptoms of respiratory disease, their production performance or general health status might be diminished. Little is known

about such relationships, but it is clear that amongst people working for prolonged periods in intensive animal buildings there is a high incidence of chronic respiratory disease.

In housing for beef cattle, air hygiene problems are easy to solve. Because beef cattle can tolerate cold conditions, high ventilation rates can be employed to dilute and remove contaminated air from buildings. However, very young calves can require special measures to prevent diseases caused by low environmental temperature. If the calves are not nursing, it will be recommended to keep calves apart of the cows e.g. outside the barn in hutches.

Natural ventilation of buildings by wind effect allows air quality to be maintained at a low economic cost.

2.3.2 Light

Illumination is important in housing, since animals need to see so they can behave normally, e.g. move, feed, or lie. It is also important for the stockman so he can inspect and care for the animals. Minimum levels of illumination (lux) are often recommended for men carrying out routine tasks and such illumination may be provided by artificial or natural light. Because natural light is cheaper, it is recommended often that an area of translucent material must be provided in the roof or walls. If in the roof, a translucent area equivalent to 8 to 10 % of the floor area is recommended. If in the walls, a translucent area 10 to 15 % of the floor area is recommended. The exact areas will be dictated by the location and orientation of the particular building with respect to the sun, especially for buildings fully occupied during the summer season. In buildings with large areas of open-

ings for ventilation, these alone may suffice for natural lighting.

For artificial illumination, one can recommend 250 lux for calving, treatment and calf pens, and 150 lux for the rest of the building (see *table 10-1*).

Reproduction can be affected by light. Considerable evidence exists to show that changes in light intensity and day length, reflecting changes in season, affect the reproduction of mammals. Allowing natural daylight into buildings will allow beef cattle to recognise such change.

Solar radiation (sunlight) directly impinging on animals can warm them in cold conditions but may contribute to heat stress in hot conditions. Direct sunlight, through the biochemical and thermal effects of specific parts of its spectrum, can kill many biological organisms and hence promotes hygiene and health.

Consequently, there are good reasons to make provision for the entry of daylight and sunlight, except when shade is required in hot conditions, into cattle buildings.

2.4 The Herdsman

The welfare of beef cattle will be influenced by the treatment they receive from the herdsman (man or woman). It is important that the presence of humans does not cause fright or induce stress reactions. The good herdsman will adopt a caring, friendly and predictable attitude towards his animals.

The herdsman will himself need good facilities to work with and will need to be relieved of laborious and tedious tasks, if he himself is not to be frustrated or stressed. If the herdsman is stressed, his frustration will often be vented on animals.

While a high level of mechanisation will lessen the burden on the herdsman, it can be counter-productive. In highly mechanised housing systems, for example, the animals may not regard the herdsman as the one, who brings the food but as the one, who carries out veterinary treatments that sometimes are painful for animals. In such situations it is important for herdsman to find other ways, in which his presence will elicit a positive response from the animals.

If animals are on pasture, the herdsman will have to visit his animals every day to check the behaviour, the attitude and the health of each animal, and to maintain close contact with animals. He has to check the availability and quality of water. If there is a bull with the cows and the calves, he will have to take all the needed measures to prevent unexpected aggressiveness of the bull and also of the cows, which can act to protect the calves.

2.5 Summary

Beef cattle should have:

- freedom of movement
- sufficient light for normal behaviour and satisfactory inspection
- sufficient water and feed to meet their requirements
- complexity and change in their environment to avoid boredom

In loose housing systems :

- dead end passages should be avoided
- there should be enough lying places or enough area for all animals
- drinkers readily should be accessible, unobstructed and regularly checked
- floors should not be slippery and should not cause excessive wearing

Chapter 3

Animals, Buildings and Equipment Dimensions

3.1 Body Dimensions of Cattle

3.1.1 Basic linear dimensions

Space requirements for basic behaviours of young stock e.g. lying, feed intake or walking depend on body dimensions of animals. Size of animals is defined by the basic measurements H = height at withers, L = diagonal body length and W = width of chest according to *Figure 3-1*.

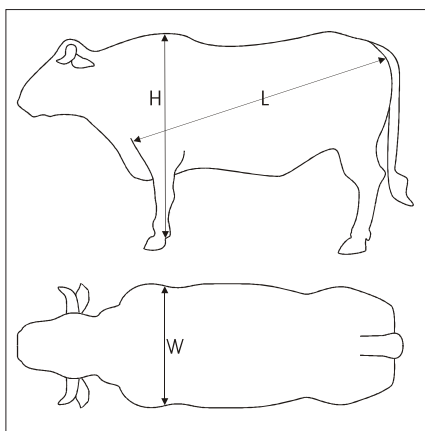

Figure 3-1: Body dimensions of cattle

3.1.2 Relationship between body weight, age and body dimensions

When judging the space requirements of stock, the age of the animal is often used as the criteria for selecting dimensions. The animal's estimated or measured body weight can also be used. As animal's age is always known and their live weight is often known the relationship between age, body weight and body dimensions could be used to determine space requirements for the animals to be housed. However, these relationships considerably can vary between different breeds, different production procedures and between individual animals of the same breed. Accurate data of the body dimensions of beef cattle from all breeds are not available. The results of measurements of the dimensions of Brown Swiss heifers of different ages showed a wide range of dimensions, e.g. 300 kg heifer had an average bodylength of 1.26 m and

a variation from 1.17 - 1.34 m. The differences between breeds of equal weight show a larger variation, e.g. a Simmental heifer shows a minimum length of 1.14 m and a Holstein Friesian heifer a maximum length of 1.40 m. While the best way to provide recommendations that can be used for practical design work is to find out the body dimensions by measuring some of the animals, agreed standards can be adopted for practical purposes. *Table 3-1* gives animal dimensions of beef cattle that can be adapted for practical design work, taking into account that designs should be based on the dimensions of the larger animals in the herd.

Table 3-1: CIGR Standard dimensions of beef cattle related to body weight

Weight [kg]	H [m]	L [m]	W [m]
200	1.09	1.17	0.34
300	1.19	1.31	0.40
400	1.27	1.42	0.46
500	1.33	1.51	0.51
600	1.38	1.59	0.55
700	1.42	1.65	0.60

In this section only loose housing is considered (because tied housing is not recommended). Loose housing systems provide more comfort for both stockmen and animals and thus improve productivity and welfare. In loose housing usually animals of equal line of production and similar age are kept in groups of at least four to five, usually up to twenty or, in large enterprises, even much more. Two major types of systems will be considered.

Loose Housing - Housing systems without cubicles provide an undivided lying area for all animals of a group. It is possible to design two-area or multiple area pens with littered lying areas or one area pens with deep bedding or without bedding. If no bedding is used, the pen floor will be designed as a fully perforated "slatted" floor or alternatively as a sloped area towards the dung removal system, so that faeces and urine of the animals are moved into

or towards slurry tanks or channels by the walking activities of the animals.

Cubicle Housing - Male cattle deposit urine beneath their body thus wetting the bedding material of cubicles. This fact usually excludes male cattle from using cubicle housing systems. Thus cubicle systems are more suitable for female animals. It is important that each animal is provided with a reasonable clean, dry and resilient bed (upon which it can lie). For female beef animals properly designed, constructed and maintained cubicles can satisfy these requirements. Since cubicle houses can work with much or with very little bedding material, they can produce either solid manure or slurry. A disadvantage of the cubicle system is the inflexibility of the cubicles. Because of their fixed dimensions they can't take into account the changing body size of the animals.

3.2 Loose Housing

Beef cattle for practical reasons are usually kept at higher stocking density than cows. This can lead to reduced cleanliness, altered or aggressive behaviour and a higher risk of injury. Space available for bulls mostly is even more restricted especially in fully slatted floor pens. While the reduction of space for movement reduces fighting and mating behaviour, ethological sound systems avoid over crowded pens.

3.2.1 Terminology

One area systems are housing systems (pens) without division of the whole area into parts of different functions. All functions (lying, feeding, exercising, excreting) are carried out in one area. The floor can be fully slatted or solid with or without bedding.

Two area systems consist of the lying area and one other area, with unrestricted access, that provides sufficient space for feeding and exercise.

Multiple area systems are those in which more than one area is provided for feeding and exercise. Any of the areas



may be provided as uncovered outside yard. The lying area is separated from the other function areas (figure 3-2a and 3-2d).

Straw yards are unobstructed bedded lying areas for a group of cattle. Bedding is spread on top of the floor, with little ($\leq 2\%$) or no gradient, and soiled bedding accumulates in a deep layer, which is removed as necessary. To keep animal clean 1 to 1,2 kg straw/m² day is required. Passages will be able to be slatted if the straw bedding is chopped or ground. The feeding area and the exercise yard could be divided (figure 3-2a) or kept in one area (figure 3-2b).

Sloped floors are unobstructed lying areas for groups of cattle, that may be bedded or not (figure 3-2c and 3-2d). The floor has a gradient of 5 to 10% and the activity of the animals causes movement of bedding and/or manure down to the bottom of the slope, where it is collected. Straw should be added daily to the highest part of the sloped floor and the cattle will spread it themselves. The

feeding area and the dunging alley could also be divided (figure 3-2d).

3.2.2 Space requirements for lying and movement in bedded system

The space for lying and rising is calculated in accordance with the animal's length and the distance required to swing its head while rising, multiplied by the width required for the animal to lie. Lying length without space for the head corresponds to body length (L). Additional space for rising can be calculated for beef cattle as $0,8 * H$ (20% less than for cows because of the young animal's ability to adopt rising behaviour in more crowded situations and move more efficiently). Width of lying space for comfortable lying corresponds to cubicle width according to equation (8) i.e.

$0,83 * H$ for heifers. Beef cattle are usually presumed to cope well enough with even more crowded situations thus lying width normally is reduced to small lying positions calculated as $0,7 * H$.

Minimum space requirements for beef cattle

Minimum lying area (LA1) for beef cattle is given by equation (1).

- (1) minimum lying area for beef cattle in pens with fully slatted concrete floors and in two area sloped floor pens (figure 3-2b)

$$LA_1 = 0.7 * (L + 0.8 * H) * H$$

Space requirements for straw yards and for two area pens with bedded lying areas

Lying areas in straw yards must be about 20% larger because of more scattered lying patterns of animals compared to those in sloped floor systems. The lying area for heifers should again be about 20% larger (broad lying positions, see above). Lying area for beef cattle in two area straw yards (figure 3-2b) and heifers in multiple area sloped floor systems (figure 3-2d) is given by equation (2).

- (2) for beef cattle in two area straw yards and heifers in multiple area sloped floor systems

$$LA_2 = 0.83 * (L + 0.8 * H) * H$$

Lying area for heifers in multiple area straw yards (figure 3-2a) or in two area sloped floor systems (figure 3-2c) is given by equation (3).

- (3) for heifers in multiple area straw yards or in two area sloped floor systems

$$LA_3 = (L + 0.8 * H) * H$$

The minimum total space for cattle in straw yards, two- or multiple area pens with bedded lying areas again is based on the individual body measurements (L, H & W) given above, the total area per animal TA_1 and TA_2 in straw yards and sloped floor systems, respectively, can be determined as values by practical experience from the following equations (4) and (5):

- (4) for beef cattle in two area systems and heifers in multiple area systems (with outside exercise yards)

$$TA_1 = 5 * L * W$$

- (5) for beef cattle in one area straw yards and for heifers in two area systems

$$TA_2 = 6 * L * W$$

Table 3-2 shows the calculated lying and total areas for different types of housing

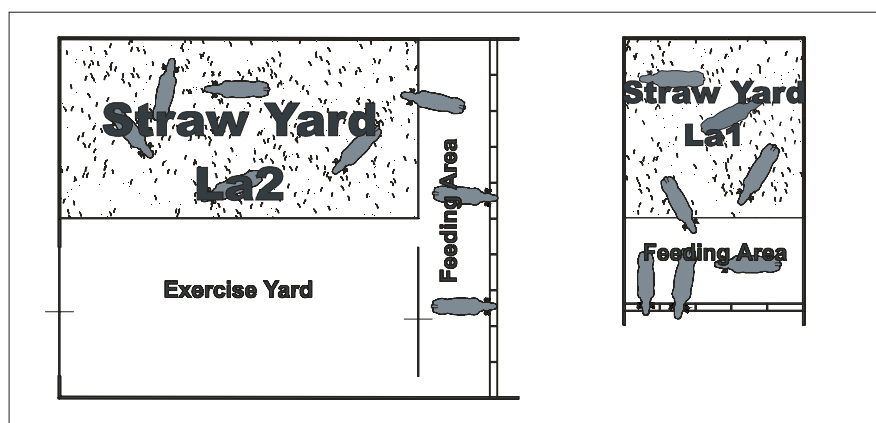

Figure 3-2a and 3-2b: Three (a) and two (b) area straw yard systems

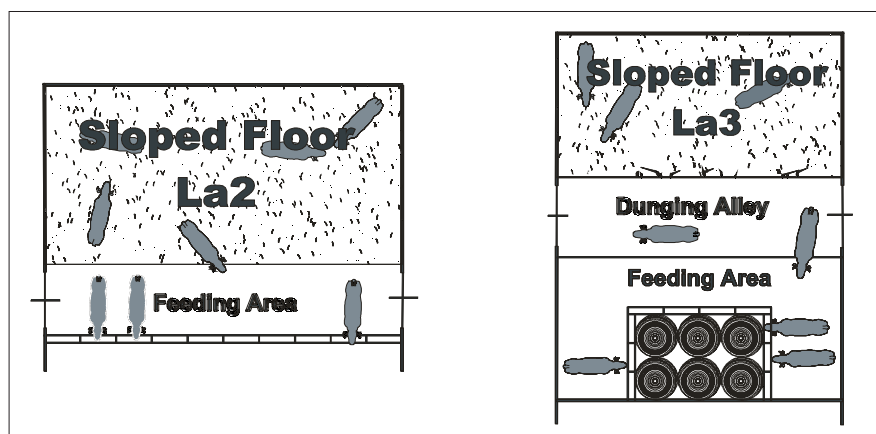

Figure 3-2c and 3-2d: Two (c) and three (d) area sloped floor systems

systems based on the sizes of cattle (at different weights) according to CIGR standard dimensions of beef cattle related to body weight.

3.2.3 Novel slatted systems

A special type of flooring (for cattle) is characterised by a fully slatted floor partly improved for the needs of lying animals by fitting lying area with rubber coated slats. Lying area in such a pen is given by equation (6) and total space required is given by equation (7).

(6) lying area with rubber coated slats

$$LA_4 = 0.55 * (L + 0.8 * H) * H$$

(7) for cattle in two area fully slatted floor pens with rubber coated slats within the lying areas

$$TA_3 = 4.5 * L * W$$

Table 3-3 shows calculated lying and total areas for cattle of different weights in two area pens with fully slatted floors and rubber coating of slats within the lying areas according equations (6) and (7).

3.3 Cubicle Housing

3.3.1 Design criteria

The space requirements of the animals with respect to lying and rising consists of :

- the space from the rear of the animal to the front of its fore knees

- space in front of the animal occupied by its head
- the additional space necessary for the thrust of the animal's head as it lunges forward during rising. About the same space will be needed for the movement of the head during standing up.

Animals can gain sufficient space for the movement of the head by sharing the space with neighbouring cubicles. Head-to-head cubicles offer the same opportunity to use the opposite cubicle to gain lunge space, provided that the fronts of the cubicles are properly designed (position of head rail). Cubicle partition should have the following three unobstructed (open) area zones (see figure 3-3):

- (i) head zone (space sharing for lunge during rising and lying down)
- (ii) zone for controlling lying position; it must be small enough to prevent from lying under the partition, but large enough to avoid trapping legs

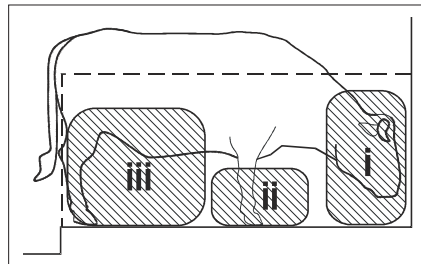

Figure 3-3: Three zones of freedom in cubicles

- (iii) zone for pelvis freedom; preventing injury to leg joints and hips and necessary for broad lying positions with hind legs stretched off from the body.

Cubicles should be provided with some means to make the floor comfortable for the animals. Satisfying materials are e.g. grained or chopped straw, wood chips or suitable comfort matting. For keeping young animals in cubicle houses it is important to have small groups.

Major features of cubicle design are fully covered in the CIGR dairy cow housing handbook.

3.3.2 Basic cubicle dimensions

The following cubicle dimensions are related to the animals' body dimensions, L and H (in metres) .

Width of Cubicles (CW)

This is calculated from equation (8) below and represents the distance between the centres of cubicle partitions.

$$(8) \quad CW = 0.85 * H$$

Cubicle Resting Length (CR)

This is calculated from equation (9) below.

$$(9) \quad CR = 0.95 * L + 0.15$$

The additional 0.15 considers the manoeuvring space the animal requires to make postural changes when lying.

Head Space (HS)

This is the space required for the head and lunging forward (head-to-head space sharing cubicles) or to the side (side-to-side space sharing cubicles) while rising and lying down.

$$(10) \quad HS = 0.35 * H$$

Overall Cubicle Length (CL)

This is an important value in the design of cattle housing. It is obtained by adding the values of CR to the values of HS according to equation (11). Equation (11) is used for space sharing cubicles and equation (12) for non space sharing

$$(11) \quad CL1 = 0.95 * L + 0.32 * H + 0.15 \quad (\text{Space sharing})$$

$$(12) \quad CL2 = 0.95 * L + 0.56 * H + 0.15 \quad (\text{Non space sharing})$$

Table 3-2: Minimum lying and minimum total areas as determined for beef and breeding cattle of different weights from equations (1), (2), (3), (4) and (5)

Weight [kg]	Body size [m]			Lying- and total pen areas according equations (5) to (9) [m ² /animal]				
	H	L	W	LA ₁	LA ₂	LA ₃	TA ₁	TA ₂
200	1.09	1.17	0.34	1.55	1.85	2.25	2.00	2.40
300	1.19	1.31	0.40	1.90	2.25	2.70	2.65	3.15
400	1.27	1.42	0.46	2.20	2.60	3.10	3.30	3.90
500	1.33	1.51	0.51	2.40	2.85	3.45	3.85	4.60
600	1.38	1.59	0.55	2.60	3.10	3.70	4.40	5.25
700	1.42	1.65	0.60	2.77	3.28	3.96	4.95	5.94

Table 3-3: Minimum lying and minimum total areas for cattle of different weights in two area pens with fully slatted floors and rubber coating of slats within the lying areas

Animals Weight [kg]	Body size [m]		Lying and total area according equation (6) and (7) [m ² /animal]		
	H	L	W	LA ₄	TA ₃
200	1.09	1.17	0.34	1.25	1.80
300	1.19	1.31	0.40	1.50	2.35
400	1.27	1.42	0.46	1.70	2.90
500	1.33	1.51	0.51	1.90	3.45
600	1.38	1.59	0.55	2.05	3.90

Typical Cubical Sizes (CIGR standard)

Table 3-4 shows calculated examples for five different weights of heifers and suckling cows.

3.4 Spatial Requirements for Passages

In cubicle and in non-cubicle housing passages connect different areas (resting, feeding, watering, collecting, exercise etc.). The minimum height of any passage (PH) required by the animals is given by equation (13) below. „H“ must be chosen from the largest animals held in the group. However, in practice, the height will be dictated by the use of the passage and needs to be accommodated to vehicles and other equipment used for cleaning the passages, delivery of food etc.

Table 3-4: Cubicle width (CW), cubicle resting length (CR), head space (HS) and cubicle length (CL1) according to body dimensions and equation (11) for space sharing cubicles for heifers and suckling cows.

Weight [kg]	Animal data		Cubicle data			
	L [m]	H [m]	CW [m]	CR [m]	HS [m]	CL1 [m]
500	1.51	1.33	1.13	1.58	0.47	2.01
600	1.59	1.38	1.17	1.66	0.48	2.10
700	1.65	1.42	1.21	1.72	0.50	2.17

Table 3-5: Width of passages for cattle of different weight (CIGR standard) according Equations (14) to (17)

Animal weight [kg]	Animal size		Width of passages			
	L [m]	W [m]	WP _a [m]	WP _b [m]	WP _c [m]	WP _d [m]
200	1.17	0.34	0.54	1.30	2.00	2.80
300	1.31	0.40	0.64	1.50	2.30	3.20
400	1.42	0.46	0.74	1.75	2.60	3.50
500	1.51	0.51	0.82	1.95	2.80	3.75
600	1.59	0.55	0.88	2.10	3.00	3.95

$$(13) PH = H + 0.2$$

Passages to accommodate typical situations and their sizing, in terms of passage width (WP), are considered below.

(a) One way (Single) traffic passages

In some cases these passages lead to and from the handling area and treatment and/or weighing facilities and to exercise yards or pasture. The minimum width required depends on the body width of the animals plus a minimum clearance for circulation. On this basis the minimum one way passage width (WP_a) is given by equation (14).

$$(14) WP_a = 1.60 * W \text{ [One way passages]}$$

(b) Two way traffic passages

These passages, often between two walls, two rows of cubicles or between a row of cubicles and a wall, serve no other

function than to allow circulation of animals along them. The minimum width of such passages (WP_b) is given by Equation (15).

$$(15) WP_b = 3.8 * W \text{ [Two way passage]}$$

(c) Single sided feeding and/or watering passages

As well as allowing circulation of the animals these passages also function as a feeding and/or watering area along one side. The minimum width (WP_c) of such passages is given by equation (16).

$$(16) WP_c = L + 2.5 * W \text{ [Single sided feed/water passage]}$$

(d) Double sided feed/water passages

These passages are similar to (c) but feeding and/or watering takes place on both sides of the passage. The minimum width (WP_d) of such passages is given by equation (17).

$$(17) WP_d = 2 * L + 1.4 * W \text{ [Double sided feed/water passage]}$$

Table 3-5 shows width of passages for cattle of different weight (CIGR standard) according to equations (14), (15), (16) and (17).

Passages in Loose Housing

In loose housing systems, submissive animals can usually avoid agonistic contacts in passageways by moving aside onto the bedded area. Consequently the width of passages adjacent to bedded areas or sloped floors can be reduced. However the reduction in passage width should not be more than 20 % of the recommended widths shown above and the overall system area (TA) should not be reduced.

Chapter 4

Floors and Walking Surfaces

4.1 Introduction

The floor surface provides the interface between the animal and the house and it is of critical importance to the satisfactory performance of the facility as it is the part of the building, with which the animal comes into closest and continuous contact. Floors are multifunctional elements and this can lead to some compromises in their design. The floor must be strong enough to support all the loads from animals and equipment where applicable. In the case of the slatted floor the gap width should be limited to prevent hoof damage but the requirement for efficient drainage will impose minimum requirements on gap dimensions. Surfaces that are too rough can cause abrasions and a rapid wear of animal hooves. A surface, which is too slippery or which has too large a slope can cause injury resulting from falling or reduce the frequency of animal movement so affecting natural behaviour. Other factors such as environmental policies must also be considered e.g. the necessity to control ammonia emissions from livestock houses is influencing new floor designs in some countries.

4.2 Floor Types

Different functional areas can be identified in animal accommodation facilities including feeding areas, resting areas and cattle traffic routes. Specific floor designs may be selected for the different functional areas e.g. solid unbedded feeding passage combined with a straw bedded resting or loafing area. However, floor systems used in beef cattle houses can be broadly classified into two main types:

- solid, unperforated floors that are laid directly on the ground
- floors that are suspended above tanks or channels and which are perforated to assist in the drainage of liquids and the passage of faecal material.

Of the solid floors, those constructed of concrete are the most common and solid floors are typically provided with bedding material. For the suspended floors, reinforced concrete is the most common material in use. Pre-cast concrete slats above a slurry pit or channel are the commonest types of suspended floor design.

4.3 Structural Requirements

When specifying floors for beef cattle houses the designer must take into account a range of factors e.g. the loadings imposed by animals and equipment, the ability to provide a non-slip surface, the method of cleaning to be used, whether bedding material is available etc. Where concrete is used either as a solid cast in-situ floor or as part of a pre-cast floor element, the aggressive nature of the environment imposed on the floor surface resulting from the chemical composition of manure and feed residues places extra demands on the quality of materials used. In addition the mechanical impact of cleaning systems can place extra loadings of the structure. In response to the special structural demands placed of floor systems several countries have developed national standards for the specification of floor construction for use in cattle housing. These standards cover issues such as structural detailing and construction practice, reinforcement specification and concrete quality.

4.4 Animal Floor Interface

Many ailments in animals are multifactorial in nature and the floor can be considered to be amongst the causal factors contributing to problems associated with the health of the feet and legs of beef cattle.

Flooring can contribute directly, through its physical properties, or indirectly, for example, by allowing (because of poor drainage) disease vectors to be harboured on the floor surface. Hoof disorders in cattle have been linked with the frequency of contact with faeces and urine.

However, the predominant effect is through the floor's ability to cause physical injury through the destruction of the physical structure of tissue to the detriment of its functioning or by bone, muscle or ligament damage caused by the animal slipping.

These effect primarily will be related to the important floor properties of friction, hardness (or softness), abrasiveness, surface texture (roughness) and surface profile (slope).

4.4.1 Friction

This is measure of the friction between two surfaces, the higher the value the greater the slip resistance. Normally two coefficients of friction are considered - static coefficient of friction when the body (foot) is at rest and kinetic coefficient of friction when the body (foot) is moving. These coefficients are defined as follows:

Static coefficient of friction, μ_s

= the ratio of the resultant friction force (F_s) to the normal reaction (N) when slip is imminent

Kinetic coefficient of friction, μ_k

= the ratio of the resultant frictional force in the plane of the interface (F_k) to the normal reaction (N) required to maintain a slip at a given velocity.

The ratio between the horizontal and vertical forces on the hoof, when a cow walks, is between 1:2 and 1:3 and this in turn means that a coefficient of friction of 0.33 – 0.5 is required. For hard materials the static coefficient of friction, μ_s , is accepted as being greater than the dynamic coefficient of friction, μ_k . However, for elastic and visco-elastic materials, like rubber, the opposite is true. Indeed the interaction between the hoof and the floor is complicated by the fact that the animal's hoofs are flexible and they act more like an elastomer. For the interaction between a hoof and a floor it has been shown that kinetic coefficient of friction μ_k is the more relevant indicator of slip resistance of livestock floors.



4.4.2 Hardness

The hardness of floor materials may be unavoidable, if they are to perform other functions such as load bearing, resistance to corrosion and damage while being practical and economic in use. Hardness, per se, is not a problem. It is its association with other factors, such as high void ratios in slatted floors, which can increase the pressure on feet or other parts of the body, or slipperiness that causes problems. The covering of slats with materials providing a soft contact surface can be considered to alleviate the problem. In the case of solid floors the use of sufficient bedding material improves the animal floor interface. Where bedding material is not available or practical to use the fitting of appropriate mats can be considered.

4.4.3 Abrasiveness

All floors made of conventional materials will be abrasive to some extent. Indeed for most hoofed animals, floors need to be abrasive to keep the hoof in good condition and prevent over growth. However, floors that are too abrasive can lead to abrasion injury to those parts of the body that come into contact with the floor, particularly knees, hocks and teats.

4.4.4 Surface texture (roughness)

The surface texture of the floor is a complex measure that dictates its anti-skid performance. Occupational safety studies concerned with surface textures in the human working environment have identified two types of roughness vital to skid-resistance:

- micro-roughness
- macro-roughness

Micro-roughness covers all features less than 0.5mm in a horizontal direction providing a safe frictional connection between the hoof and the surface. In concrete, micro-roughness is a function of the surface roughness of both the aggregates and the surface mortar. It is reduced over time by the grinding and polishing action of mechanical cleaning equipment and animal movements but these effects can be counteracted by using concretes with high strength and coarse

and fine aggregates with a high polishing resistance. Macro-roughness covers surface features greater than 0.5mm and the provision of adequate macro-roughness is necessary to establish a safe frictional connection between the hoof and the floor when the surface is soiled or wet. Anti-skid performance is particularly improved by features with a maximum size of 10mm. Macro-roughness in animal housing floors can be produced by making impressions in the fresh concrete or by milling/cutting the floor when the concrete has hardened.

Animal's hoofs deform when they slide over a rigid surface. This deformation means that hoof deforms around irregularities in the floor surface, giving rise to a total friction made up of two components. The first is the adhesion component of friction between the hoof and the surface and the second due to the delayed recovery, hysteresis, of the hoof after being deformed by an irregularity.

On dry concrete floors, there is some conflict about whether it is smooth or rough surfaces that give the best slip resistance. However, since livestock floors, particularly those over which they are moving, are very likely to be wet, then this of little consequence. Wet floors are effectively covered in a lubricant that is likely to make adhesion component very small.

Thus it is the hysteresis component that must be relied upon to give grip. On a smooth surface, a film of liquid (slurry or water) lies on the surface and the hoof cannot come into contact with the floor so slipping occurs. If the surface has a texture or grooves that allow this liquid film to be squeezed away, rapidly, then the hoof will come into contact with the floor before a slip occurs. These effects are analogous with smooth tyres and aquaplaning in a motor car.

A roughened surface, whilst it may allow rapid dispersal of the liquid film, may provide only a small hoof/floor contact area. This can lead to excessive contact pressure and in extreme cases puncturing of the sole of the foot. A surface with appropriate grooving, which allows rapid liquid drainage and provides hysteresis as the foot contacts the groove, is a more acceptable solution.

This is analogous to the tread in a car tyre.

4.4.5 Surface profile

While surface profile has been used in the past by others to describe some of the mechanisms affecting slip already considered above in the context of this exercise surface profile is taken as describing the slope or gradient of the floor.

Slope will have obvious effects on drainage from the floor, on floor cleanliness and on the comfort of animals standing, walking and lying on the floor. Steep slopes will obviously allow liquids to drain rapidly from the floor and might prove an aid to cleanliness by ensuring that soiled bedding "flows" down the slope. However, animals may not be able to stand, walk or lie comfortably on steep slopes.

Floor slopes in passageways should not exceed 1:40 (2.5 %). In pens where animals lie the slope used will depend on the type of bedding and manure management system utilised. In sloped floor systems, which rely on the movement of animals to transfer soiled bedding to the manure collection area slopes of 1:10 (10 %) are required. In facilities where straw remains in the pen a slope of 1:20 (5 %) will ensure extraneous liquid is drained to appropriate channels.

4.5 Flooring Materials

All materials used in the construction of floors should be non-toxic to cattle and be resistant to or protected against:

- chemical attack and deterioration
- climatic conditions, e.g. extremes of temperature, frost, solar radiation
- the effects of pressure washers, etc.
- the effects of gnawing, digging or other animal behaviours

Concrete is the predominant material used for floor construction with the material being in direct contact with the animals where the floor is slatted or no bedding material is used.

4.5.1 Solid concrete floors

Concrete used for floors in cattle houses must be designed to cater for the loads imposed by the animals and vehicles, which are used during feeding and clea-

ning operations. The surfaces must be resistant to mechanical damage (abrasion, chipping etc.) and chemical attack (manure, feed residues, cleaning chemicals and disinfectants). The floor must provide an impermeable barrier to ensure the safe collection of any effluents produced. There are various national standards regarding the specification of concretes for use in the floors of cattle buildings. Typically these specify concretes with a characteristic 28 day crushing strength of 30N/mm² with a minimum cement content of 280kg/m³ and a maximum aggregate size of 20mm. Where the concrete may come in contact with silage effluent the 28 day crushing strength requirement is increased to 40 N/mm² and the minimum cement content increased to 350kg/m³. The concrete floor should be provided with mesh reinforcement and appropriate movement (expansion and contraction) joints in accordance with national standards. Floors in areas used by vehicles should not be less than 150 mm thick. Where access is limited to animals the minimum can be reduced to 100 mm but this would not be a general recommendation as the use of the floor may change. Where bedding material is provided the actual animal interface with the floor is

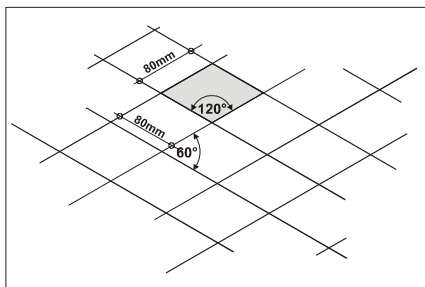

Figure 4-1: Grooves in diamond pattern

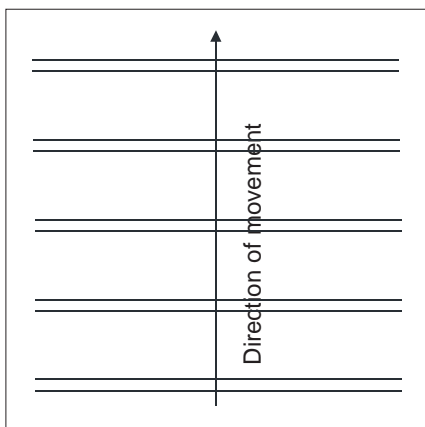

Figure 4-2: Grooves in parallel

modified and the comfort and slip resistance characteristics are those of the bedding material. Where animals have direct contact with the surface the recommendations provided in CIGR Design Recommendations for Dairy Cow Housing should be followed. In order to provide slip resistance for cattle walking in all directions and to eliminate the risk of high pressure on the hoof, grooves should be formed in the solid concrete prior to setting in a pattern of rhomb with 80 mm sides as shown in *Figure 4-1*. If this cannot be achieved then parallel grooves spaced at 40 mm between centres should be used. If the direction in which the cattle are likely to be walking is known then the grooves should run at right angles to this as shown in *Figure 4-2*. In all cases the grooves should be 10 mm wide and at least 6 mm deep.

4.5.2 Slatted floors

In areas where bedding material is not readily available combined with the need to reduce labour demands and the necessity to ensure manure is efficiently collected and safely stored has encouraged the development of beef cattle housing systems using slatted floors suspended over manure storage tanks or transfer channels.

Slat design has improved and modern facilities are using multi-rib or “gang” slats rather than the single slats that were used in the original units. The resulting floors are more uniform level and provide a potentially better surface in terms of comfort for the animal. The length of slatted elements provided by manufacturers has increased over time and units are now available up to 4.8 m long. There are variations within the range of slat types produced by different manufacturers in terms of void ratio and this

will also influence the comfort aspect of the animal floor interface as well as the drainage characteristics and cleanliness of the animal. The latter is also influenced by feed type and the ventilation system used of the building. The nominal void ratio of different slats is presented in *Table 4-1*.

Several nations have developed standards for the design and manufacture of concrete slats for cattle houses e.g. British Standard, BS 5502; Irish Standard IS 249. Work is underway to establish an agreed European Standard - Precast Concrete Floor Slats for Livestock. This standard classifies slats according to the type of housed stock and load classes are given according to the animal mass. Requirements are formulated for concrete mix components and concrete strength, size and position of reinforcement, floor slat geometry, surface characteristics and mechanical strength. As regards durability, the demands are that the water/cement ratio of the concrete should be no more than 0.45 and the cement content should be no less than 350 kg/m³ at a concrete cover < 40 mm and 300 kg/m³ at a concrete cover > 40 mm. The water absorption of the concrete (5% quartile) should not exceed 6 % by mass. The concrete cover to be applied on the outer reinforcement should be at least 30 mm for reinforced concrete components and 40 mm for prestressed concrete components. This value can be reduced by 5 mm, if the maximum aggregate particle size does not exceed 20 mm. These standards are still at a draft stage and are in fact exceeded by some present national standards which are presently in place.

In some building designs slatted floors are located in areas, which are also accessible to tractors and other vehicles. Special heavy duty slats must be provi-

Table 4-1: Free area of different slat (rib and gap dimensions in mm)

Rib/gap (Void ratio)	125/25 (17)	125/30 (19)	125/35 (22)	125/40 (24)	125/45 (27)
	135/25 (16)	135/30 (18)	135/35 (21)	135/40 (23)	135/45 (25)
	145/25 (15)	145/30 (17)	145/35 (19)	145/40 (22)	145/45 (24)
	150/25 (14)	150/30 (17)	150/35 (19)	150/40 (21)	150/45 (23)
	170/25 (13)	170/30 (15)	170/35 (17)	170/40 (19)	170/45 (21)

ded in these areas to cater for the axle loadings involved.

The dimensions shown below are derived from a number of national standards including BS 5502: Part 51.

This standard gives further details including structural considerations, tolerances and opening details for these types of floors.

The definition of the terms used in the following tables are as follows:

Preferred Width

the width of a single slat or solid portion between voids in multi-rib slats (a panel consisting of parallel slats).

Spacing

the clear distance between solid portions of slats. The minimum and maximum figures in the range shown, indicated the shortest and longest distances (measured across any shape of void).

Void Ratio

the unobstructed floor area through which waste can pass expressed as a percentage of the total floor area.

Table 4-2 shows dimensions recommended for cattle floors. These floors are usually in the form of single or multi-rib slats.

The use of fully slatted floors for certain animals is limited or not recommended

Table 4-2: Dimensions of slatted floors for cattle

type of animal	preferred width mm	spacing "S" mm	void ratio %
Calves and young stock > 200kg	80-120	20-30	18-25
Beef animals > 550kg	100-160	30-40	18-25

in some animal welfare codes, e.g. totally slatted floors should not be used for calving cows, cows with young calves or calves of less than 4 weeks of age. Manufacturers have developed slat covering systems where soft materials are fitted to the slat ribs to improve the animal floor interface. These products have been shown to be beneficial when used in fully slatted pens for beef animals with the improved comfort provided to the animals leading to improved performance. Concerns regarding the emission of ammonia emissions from cattle buildings have led to the development of some novel floor systems. One such design - "grooved floor system" has been developed in The Netherlands and is used at present for walking areas in dairy cow facilities. The grooved floor system consists of solid level pre-cast concrete elements covering a manure pit. The floor is scraped with a mechanical scraper. The top surface of the floor consists of a series of parallel grooves 35 mm wide and 30 mm deep and placed at 160 mm cen-

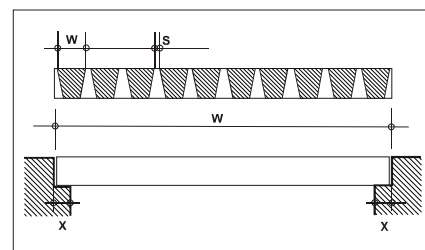

Figure 4-3: Slatted floor

tre to centre. The width of the solid flat area (i.e. area between the grooves) is 125 mm, which is similar to the rib width of a slatted floor. The floor elements are 1.1 m long and the adjacent edges of the abutted elements are tapered, which forms a self-discharging perforation at the base of the grooves for the urine deposited on the floor (total area of perforations is < 0.5 % of floor area). The faeces is removed by a mechanical scraper to an opening at the end of the passageway. To ensure the grooves remain clean and to prevent the perforations becoming clogged, the blade of the scraper is fitted with a tooth shaped rubber strip.

Chapter 5

Facilities for Feeding and Drinking

5.1 Introduction

The following dimensions apply to loose housing systems, which permit indoor feeding so cattle can eat regardless of the weather. Maximum performance, particularly of heavier animals, can only be achieved by providing unrestricted access to the fodder, the availability of enough feed over the whole day of adequate quality according to type of animal, weight and production targets.

Welfare aspects have also to be considered. Stronger animals can disturb weaker ones in an aggressive way by inhibiting them from eating or drinking. A more or less unrestricted access to the feed should be possible for the hierarchically lower animals. Furthermore, it has to be considered that cattle are spending at the manger about six hours a day. Abnormal body posture of cattle during feeding can cause damage to legs, shoulder, neck and so on.

Feed handling is strenuous physical work for farmers and employees, both regarding working time requirement and ergonomic aspects. The building dimensions should offer enough space for the required feed processing equipment, feed transport equipment and free access to storage places.

5.2 Feed Manger Space

Feeding management determines feed manger space requirement and two different feeding management systems are to identify:

Limited feeding:

With limited feeding, one feeding place for each animal is required. This involves the provision of adequate feed mangers, allowing large volumes of feed (once-daily feeding) or frequently pushing the fodder against animal in flat alley. The space requirement of the manger depends on the age and weight of the animal.

Unrestricted feeding:

When feeding is available all the time, design can be based up to three animals for each feeding space, depending upon local animal welfare regulations. At a feeding place/animal ratio less than 1, feed

must be offered ad libitum, in a constant quality and - as recommended - provided several times per day in form of feed mixtures. The feed manger space requirements for one animal depends on the chosen feeding system, the age and weight of the cattle and their production intensity (*Table 5-1*).

5.2.1 Feed barrier dimensions

The feed barrier dimensions must allow an easy access to fodder and a natural feeding behavior of the animal. Feeding barrier dimensions vary according to animal weight (*Figure 5-1*, *Table 5-2*).

5.2.2 Manger design

The usual manger type - feeding table - has a flat feed surface. One disadvantage is that the feed can be pushed away by the animals during feeding and must be brought back regularly into their reach. In smaller herds, this is done manually, for larger stock numbers it pays to use mechanical equipment (front- or rear mounted brushes, rotors, etc.). There is a range of acid proof coverings to protect the manger surface from corrosion e.g. plastic shells, stoneware shells, polyester-based coatings, stainless steel.

Table 5-1: Feed manger space requirements

Weight (kg)	Age (Months)	Feed manger space requirements for one animal (m)				
		restricted feeding	Unrestricted feeding Feeding place/animal-ratio			
			1.5	2.0	2.5	3.0
200	6-8	0,45	0.30	0.23	0.18	0.15
300	9-11	0,50	0.33	0.25	0.20	0.17
400	12-14	0,60	0.40	0.30	0.24	0.20
500	15-19	0,70	0.47	0.35	0.28	0.23
700 ¹⁾	20-24	0,75	0.53	0.40	0.32	0.27
900 ¹⁾	25-30	0.75	0.57	0.43	0.34	0.28

Table 5-2: Feed manger and feed barrier dimensions (in m)

Weight (kg)	see Fig. 5-1					Neck rail height (Fig. 5-1)
	A	B ²⁾	C	x	F ³⁾	G
200	> 0,10	0,40	> 0,15	0-0,3	0,40	0.74
300	> 0,10	0,45	> 0,15	0-0,3	0,50	0.84
400	> 0,10	0,50	> 0,15	0-0,3	0,55	0.92
500	> 0,10	0,55	> 0,15	0-0,3	0,60	1.00
700 ¹⁾	> 0,10	0,60	> 0,15	0-0,3	0,70	1.10
900 ¹⁾	> 0,10	0,65	> 0,15	0-0,3	0,75	1.15

¹⁾ suckling cows, ²⁾ max. value, ³⁾ min. value

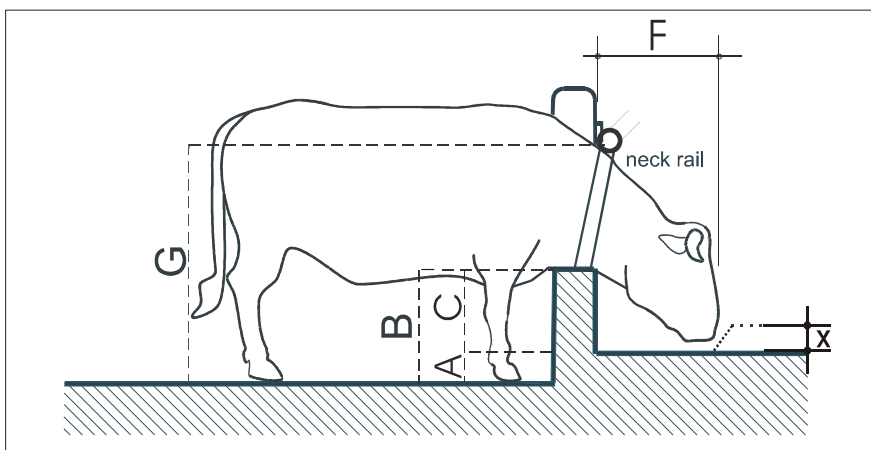

Figure 5-1: Feed manger dimensions

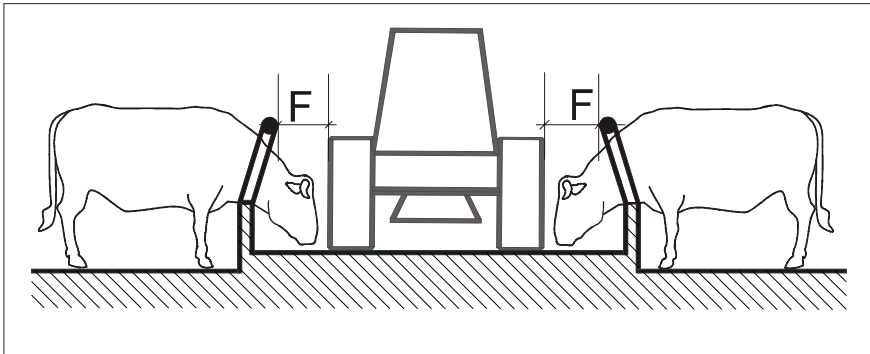

Figure 5-2: Feed alley dimension for tractors, block-cutter, mixer wagon

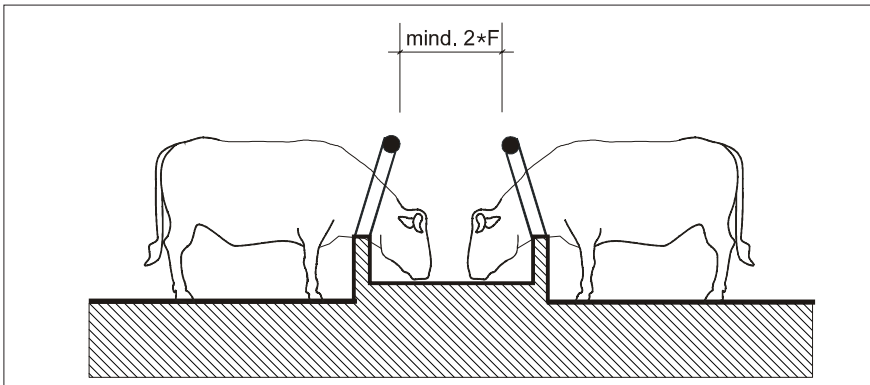

Figure 5-3: Feed alley dimension for feed conveyor

Mechanical devices such as feed conveyors and flexible mangers (adjustable tarpulin or sheet) help optimize the deli-

very of the ration and reduce feed waste and working time.

Table 5-3: Head space dimension for tombstone and diagonal feed barrier (m)

Weight (kg)	see Fig. 5-4 D	see Fig. 5-5 E ¹⁾
200	0,14	0,20
300	0,18	0,22
400	0,2	0,25
500	0,23	0,28
700	0,25	0,30
900	0,27	0,32

¹⁾ hornless animals

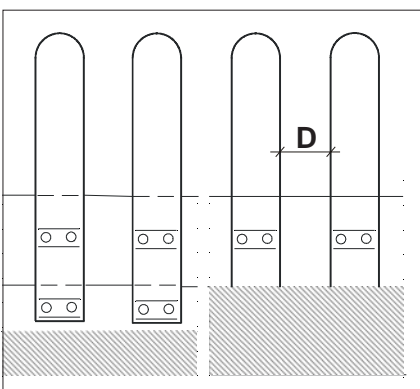

Figure 5-4: Feed barrier with tombstone

5.2.3 Feed barrier designs

A frequently used feed barrier is the tombstone barrier. They are cost-effective and suitable for self-construction because of the use of wood. Also diagonal bar barriers are used (unsuitable for horned animals). In tombstone barriers, the spaces between the bars are determined by the neck dimensions (Figure 5-4, Table 5-3, „D“), in diagonal bar barriers by the head dimensions (Figure 5-5, Table 5-3, „E“). The simple neck rail has to be fixed at the correct height (Fig. 1). The simplest means of restraining animals is the neck rail. It must prevent animals from moving too far forward without hindering them in feeding.

Self-locking barriers are universal in cattle fattening, because they are expensive and susceptible to trouble due to movable parts. However, they are often used for suckling cows.

Where a passage cannot be provided in the rear of the pen, the feed barrier must be removable for moving the animals across the feeding area. For easy access to the pen a special personnel entry should be installed.

5.3 Feed Alley Design

The feed alley and access dimensions are determined by the kind of mechanised feeding system used. The alley dimensions must be large enough for passing with different equipment:

1. Transporting of feed using a two-wheeled trailer or blockcutter and manual feed distribution (Figure 5-2).
2. Transporting and distribution of feed using a mixer wagon (self-propelled or tractor-trailed). The turning radius plays an important role especially in trailed systems (Figure 5-6).
3. Feed conveyor (Figure 5-3): When using a feed conveyor, the required width is determined by the manger depth (Figure 5-1, Table 5-2, Pos. „F“).

5.4 Self-feeding Facilities

The importance of self-feeding systems is decreasing. Two different systems are possible: self-feeding of silage (e.g. maize silage) accounting for a substantial part of the ration, or the use of hay feeders for supplementary feeding of roughage (hay, straw) inside the building or on the pasture.

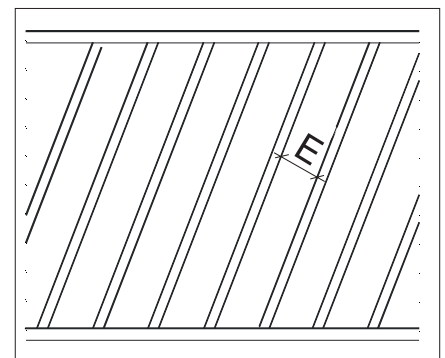

Figure 5-5: Feed barrier with diagonal bar

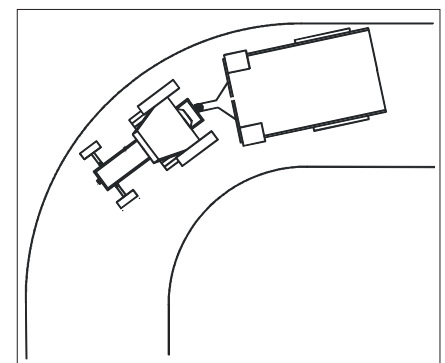

Figure 5-6: Turning radius from tractor with mixer wagon are important

5.4.1 Self-feeding in horizontal silos

The height of the silage pile must not exceed the animals' reach (approx. 1.80 m). The silo width depends on the group size of the animals. A range of barrier designs are used in practice to restrain the animals.

Unrestricted access to silage allows more than one animal to be kept per feeding place. Individual concentrate distribution being impossible, this system is recommended only for extensive fattening.

5.4.2 Hay feeders

Hay feeders are suited for supplementary feeding of roughage in intensive fattening or grazing systems. A variety of feeding racks are available on the market (*Figure 5-7*). The feeding place width is determined by the animal weight. Feeders must be large enough to hold big bales.

5.5 Drinking Facilities

Beef cattle must have free access to water, both indoor and on the pasture. Water requirements depend on the animal weight,

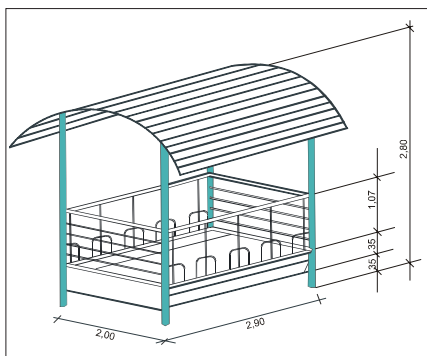

Figure 5-7: Hay feeders

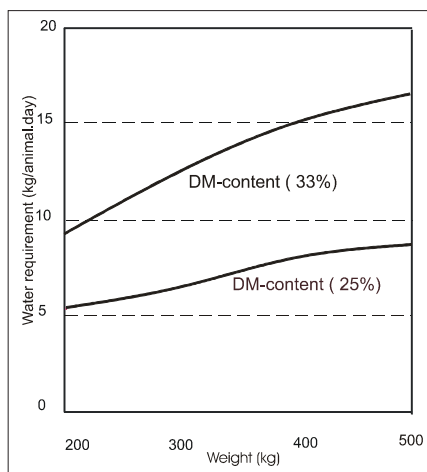

Figure 5-8: Water requirement

the dry matter content of the ration and the ambient temperature (*Figure 5-8*).

In general the requirements are as follows

- Drinker designs must take into account the cow's natural drinking position, i.e. they must allow the animals to immerse their muzzles a few centimeters in the water.
- Drinkers must be at least 0.1 m deep. Diameter of the bowl: 0.25 m. Water should be supplied at a minimum water flow rate of 8 l/min.
- Since beef fattening is performed mainly in cold housing systems, the drinkers and supply pipes must be protected from frost.
- When using drinking facilities on pastures the natural subsoil must be stabilized and drained in order to prevent waterlogging.

5.5.1 Number and location of drinkers

One water bowl per 10 animals, one water trough per 15-20 animals.

2 drinkers for each group

Height above the floor: > 0.55 m.

Drinkers should not be located in the manger area, but in a separate area of the fattening pen.

Integration of the drinker in the partition between adjacent pens allows two groups of animals to be watered with the same drinker.

For bigger groups it is recommended to adapt the size of the water troughs. Enough space around the drinking place should be provided.

5.5.2 Drinker types

Water troughs: The recommended width and depth are 0.40 m each. The length depends on the group size and the type of trough and should be at least 0.40 m. The trough should allow easy cleaning (inlet nozzle, water stop valve). A distance barrier helps reduce soiling of the trough.

Ball drinkers: The container is made of a sandwich-wall. A float is used to control the inside water level. The supply pipe is placed sufficiently below the ground surface and the ascending pipe is insulated in order to prevent free-

zing. The water quality has to be controlled regularly. This type of drinker is not recommended in cattle fattening.

Water bowls: Water bowls are generally made of cast iron with a corrosion-resistant inside coating. Water is supplied by pushing down the trigger. The inflow rate can be adapted to a given water pressure by varying the inlet nozzle size. Water inflow rates of up to 20 l/min are possible. Electric heating of the supply pipe, valve, and bowl ensures functioning at temperatures as low as -25 °C.

Nipple drinkers: These are not recommended for ruminant because they do not allow a drinking style appropriate to this species. Reduced water intake and false behavior such as urine drinking will result.

5.5.3 Frost-proof water supply

In cold and open housing systems, the water-supply pipe of the drinker must also be functional during winter. This can be assured by the following three methods:

1. Laying of the water-supply pipe in a frost-proof area, depending on climatic conditions (location of the housing system), at approximately 0.50 to 1.00 m deep. For a failure-free operation, the connections to the drinkers (water trough, drinking bowl) must be heated and/or insulated (according to the climatic conditions and flow rate).
2. Wrapping the supply pipe by means of a heating cable and insulating material. The heating cable assures a minimal water temperature. The heating capacity is automatically regulated according to outdoor temperature. In the area where the animals stay, the heating cable and insulation have to be protected against damage.
3. Connecting the drinker to a closed circuit. The temperature sensor records the water temperature. If it drops below a certain reference value, the circulating pump will produce a cycle. If the value continues to decrease, i.e. below the reference value in the temperature range of freezing, the water within the circuit will be heated by a water heater. In addition, it must be assured that the water-supply pipes outside the circuit do not freeze (accompanying heating system, insulation).

Chapter 6

Ventilation (Environmental Control) of Livestock Barns

6.1 Introduction

Beef animals will well perform over a wide range of air temperatures if proper consideration is given to their surroundings. In cold weather, young calves and older cattle alike will be able to adapt to very low temperatures if a deep and dry litter is provided along with abundant fresh air without excessive draughts and high humidity. In hot weather, shade and fresh air help to avoid excessive temperatures that lead to heat stress. Rapidly-moving fresh air (1-3 m/s) over the body of the animal increases the rate of convective heat transfer to the ambient air.

6.2 Ventilation

Ventilation - directly and indirectly - impacts many aspects of animal health. Good ventilation assures that animals breathe quality air, important to respiratory health. Good ventilation helps to keep bedding dry, a factor in favor of good animal health. Good ventilation along alleys helps to keep walking surfaces dry, a condition that contributes to healthy feet. Good ventilation may lead to greater productivity; e.g., maintaining air movement in the area of the feed manger makes the cattle more comfortable, especially important during hot weather as an aid to maintaining dry matter intake. A comfortable, well-ventilated stall area encourages animals to lie down, an important contribution to many aspects of animal health.

The ventilation process brings outside air into the barn where it collects moisture, heat and other contaminants. Air is then exhausted to the outside. Ventilation is an air exchange process - contaminated air inside the barn is exchanged for fresh outside air. To determine ventilation rates, we focus on the moisture content of the air, measured by relative humidity. But moisture is only one aspect. Ventilation removes other undesirable contaminants as well.

6.2.1 Air quality

Animal health and disease are influenced by air quality. Air quality, in turn, is rela-

ted to ventilation and its impact on reducing concentrations of contaminants in the air. Empirical observations and field trials suggest that the aerosol spread of pathogens between animals and the influence of air pollutants on pulmonary defense mechanisms are important, especially to respiratory health. Excess moisture, gases and other contaminants in the air are considered to be problematic as well.

The term air quality itself is not easily defined. With respect to animal spaces, good air quality generally implies that the characteristics of ambient air bear no harmful effects on the animals in the space. Ambient air is a mixture of clean, dry air (a mixture of gases, chiefly nitrogen and oxygen) and varying amounts of water vapor. At high concentrations, even moisture in the air in an animal space is considered to be a problem and is then considered an air contaminant. Other contaminants may include pathogens, harmful gases, dust and undesirable odors. The contaminant itself does not give rise to concern. Rather, it is the concentration of a contaminant above some predetermined level that causes concern and is considered when assessing air quality.

In hot weather, ventilation improves the environment for animals by removing heat and other contaminants from the animal space. Higher air velocities (1-3 m/s) over the body of the animal increase the rate of convective heat transfer from the animal's body to the ambient air.

6.2.2 The dilution effect of ventilation

Ventilation is truly a process of dilution. Air moved through a barn serves to dilute the inside air and, very importantly, to dilute all of its components. Dilution reduces concentrations of moisture and heat. Dilution reduces concentrations of airborne disease organisms, harmful gases and dust, and undesirable odors as well.

Reducing ventilation below recommended levels - usually in a misguided effort

to warm the barn using animal heat - results in less moisture being removed. If substantial quantities of heat are added to the air, relative humidity may remain in an acceptable range, as measured, and air quality may be deemed to be satisfactory. But even though excess moisture may not be apparent, the reduced dilution does indeed result in increased concentrations of airborne disease organisms, harmful gases and dust, and undesirable odors. If these increases are ignored, animal health problems are inevitable.

Air quality is more than just measuring relative humidity. Through ventilation the air inside the barn is continually diluted, assuring that the air available to the animal has low concentrations of all contaminants that threaten the animal's health.

6.2.3 Minimum continuous winter ventilation

A minimum rate of ventilation is required in animal housing in the winter regardless of outside temperature, whether the barn is designed to be a warm barn or a cold barn. In addition, the minimum ventilation should be continuous. Continuous dilution of inside air acts to maintain concentrations of contaminants in the air at minimal levels. The minimum rate depends on outside weather design conditions, number and type of animals in the barn, age and size of animals, and whether the barn is intended to be cold or warm.

Deciding between warm and cold housing is critical to the design and subsequent management of the ventilation system. Understanding the differences between the two types of environments is especially important as related to the need for maintaining the minimum continuous ventilation for winter in either situation that is in the best interest of animal comfort and health.

Cold housing with natural ventilation is preferred for beef animals. Natural ventilation depends upon thermal and wind forces to provide air exchange.



6.3 Ventilation Design and Operation for Cattle Barns

6.3.1 Uninsulated barns with natural ventilation

In a cold barn, indoor temperatures are allowed to fluctuate with outdoor temperatures. In winter, ventilation must be sufficient to maintain indoor temperatures within 3-5°C of outdoor temperatures. During summer, ventilation should be sufficient to maintain indoor temperature at or slightly below outdoor temperature. Moisture naturally present causes the barn itself to act as an evaporative cooler.

A cold barn with natural ventilation has these general characteristics:

a) no insulation, b) open ridge and eaves, and c) sidewalls and endwalls that open. Providing an open ridge and open eaves has long been recognized as a mean of creating a stack effect to cause air exchange, especially for controlling moisture in winter. Provide a ridge opening of 5 cm per 3 m of barn width and equivalent open area divided between the two eaves. Raised ridge caps are to be avoided. Spaced roof sheeting (gap between sheets 2cm) can also be effectively used to provide a uniform air escape pathway over the complete roof structure. However, care must be taken with this form of construction in areas where snow may cause blockage of the ventilation openings.

Summer ventilation mainly depends on the wind. Factors affecting ventilation rates due to wind include area of building openings, local obstructions (hills, vegetation, nearby buildings) and wind speed and direction. To obtain maximum air exchange rates due to wind forces, maximize inlet and outlet openings and site buildings for maximum exposure to existing winds. Orienting buildings perpendicular to prevailing warm weather wind is preferred (*Figure 6-1*). Although, if sidewalls and endwalls are completely open and the barn is not long, say less than 30 m, orientation will be less critical.

If a wind is blowing, a combination of thermal and wind forces will provide air exchange. Fresh air enters through eave and sidewall openings, *Figure 6-2*. Air

containing heat, moisture and other contaminants exists through the open ridge and downwind sidewall openings. Even with sidewalls closed on calm days, some air exchange occurs as a result of the chimney effect.

Various materials and methods may be used to cover sidewalls for colder weather. Automatic control or even frequent manual adjustment of air inlets is unnecessary. Cattle can tolerate usual diurnal fluctuations in environment and even fluctuations during the season, especially in summer. The simplest and cheapest method of covering sidewalls uses a fabric covering over the full sidewall. For summer, the fabric is manually rolled up as a rug and tied (*Figure 6-3*).

To close the sidewall, ties are released and the hanging curtain is then fastened in place using a vertical nailing strip at each post and horizontal nailing strips all along the bottom. A variation on fabric covering is shown in *Figure 6-4*. Fabric curtains to cover the top half and the bottom half of the sidewall are operated independently. A curtain is rolled up by fitting a crank to the small-diameter metal pipe installed in the hem at the bottom edge of each curtain.

In regions that do not experience high temperatures or where animals will not occupy barns in summer, permanent “porous” sidewall construction is used. This can take the form of spaced boarding (e.g. 5 - 15 cm wide timber laths with 1.5 - 3.0 cm gaps) with height depending on the free area required. Alternatively proprietary ventilated sheeting or flexible material can be used and manufacturer’s data for free area of different types should be used for design purposes.

The combination of the open ridge and eaves may be viewed as the sole source of ventilation only during the most severe winter weather - during periods when temperatures reach the lowest levels or times when especially windy, stormy conditions are present. During all other times in winter, additional ventilation must be provided. Typically, doorways are left open for this purpose. Or, sidewalls away from prevailing winter winds may be left open. Then, as temperatures rise into spring and summer, sidewalls and endwalls are ful-

ly opened. As a general rule, too much ventilation is preferred over too little.

In winter, suspend a thermometer inside a cold barn. If the temperature inside is more than 3-6° C above outside temperature, more ventilation will be necessary. Also, persistent condensation on the underside of the roof is a further indication that additional ventilation openings must be provided.

In summer, barns with open sidewalls and endwalls have improved ventilation resulting in lower average temperatures inside the barn. But, the real advantage to the cattle has to do with the extremes; specifically, during the heat of the day and the cool of the night. Cattle are not only exposed to lower temperature peaks during hot weather, they are exposed to these peaks for shorter periods of time. In addition, inside temperatures closely follow outside temperatures as they lower at night, allowing cattle to take

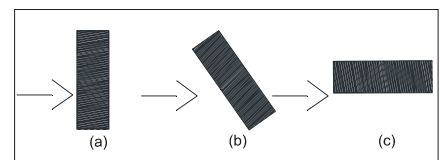

Figure 6-1: Orientation of a building according to wind direction (perpendicular to the wind, at an angle to the wind, parallel with the wind)

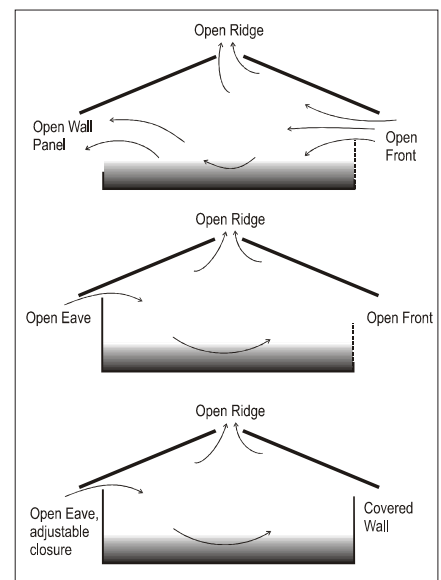

Figure 6-2: Airflow in naturally ventilated buildings. Air flow patterns vary with wind direction and velocity. From Dairy Freestall Housing and Equipment, MWPS-7, Seventh Edition, MidWest Plan Service, Ames, IA. 2000

advantage of whatever cooling effect may result from lower nighttime temperatures.

6.3.2 Insolated barns with mechanical ventilation

In an insolated barn, indoor temperature is maintained substantially higher than outdoor temperature during winter, at 5°C or higher to keep water lines from freezing or, as in the case of a calves nursery, at about 10-15°C with the addition of sup-

plemental heat to meet the needs of the animals. These buildings are well insulated. Fans with thermostat controls automatically regulate the ventilation rate as outside conditions change, diurnally and seasonally. Three levels of ventilation, using fans, must be provided if cattle occupy the barn year-round. Summer ventilation rates of 60 to 90 air changes per hour are not uncommon, requiring several fans. These levels are on the or-

der of ten times the minimum continuous rate for winter.

6.3.3 Warm barns with natural ventilation

Well-regulated, naturally ventilated warm buildings, relying on stack and wind effects, have been successful. Natural ventilation for warm barns lowers investment and operating costs. Insulation and a warm environment in winter are the same as with mechanical ventilation. Adjustable openings provide for modulating both the stack effect and the wind effect as necessary, depending upon outside conditions. Because frequent adjustments in ventilation openings, sometimes several times per day, are required to compensate for changes in outside conditions - wind velocity or direction, temperature, solar radiation, ventilation openings are usually opened and closed automatically by various types of actuators controlled by thermostats.

Natural ventilation for warm housing has been described by Choiniere, et al. (1990) for buildings that are temperature-controlled in winter.

6.4 Consequences of Mismanaged Ventilation in Winter

6.4.1 Reduced dilution of ambient air

A major reason for air quality problems in barns in winter is adjusting natural ventilation for the worst case - severe winter weather - and not readjusting to allow increased ventilation when milder winter weather appears. Ventilation openings that are closed in anticipation of a windy, cold, blustery night must be opened the next day when, although the temperature may still be cold, the wind subsides and the sun shines. Reduced ventilation due to no wind reduces ventilation, reducing air exchange and reducing the positive effects of dilution.

Problems are likely also during winter, spring and autumn, especially during rainy weather and warmer days coupled with cold nights. Ventilation reduced by manually closing ventilation openings for conditions at night is inadequate for warmer days that follow, unless openings are again uncovered. Closing ventilation

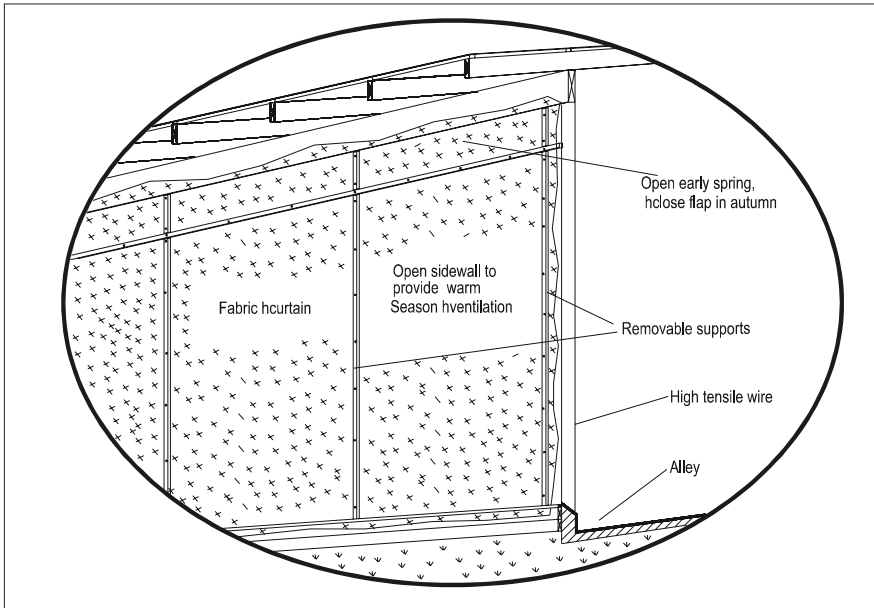

Figure 6-3: Full-wall ventilation provided by removing fabric curtain. Nailing strips are removed and curtain is rolled to the horizontal member near the top of the wall and tied in place during warm weather.

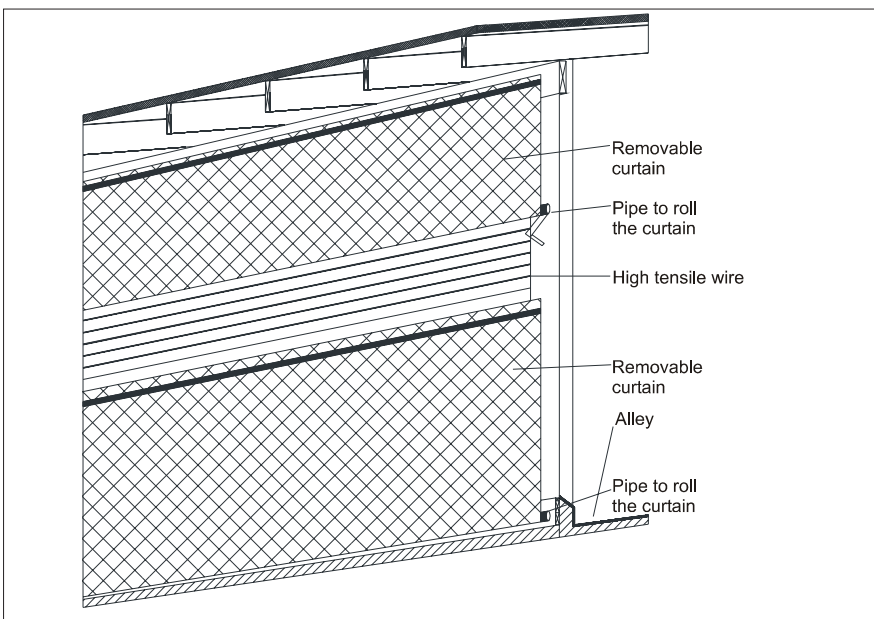

Figure 6-4: Full-wall ventilation with curtains on the upper half and lower half of the wall operated separately. Curtain operation is accomplished with a small-diameter metal pipe installed in the hem at the bottom edge of the curtain and a simple crank at the end for turning the pipe.

openings to restrict airflow to keep manure from freezing in winter can result in too little ventilation and poor environmental conditions.

To assure sufficient dilution of inside air and healthy conditions for animals, maintain a maximum temperature difference between inside and outside of no more than 3-6° C.

6.4.2 Building components affected by poor ventilation

Besides adversely affecting the animal environment, the design and operation of naturally ventilated barns influence moisture related deterioration in wood members and metal fasteners. American specialists studied 10 naturally ventilated dairy free stall barns located in Michigan. In barns where air exchange in winter was defeated by blocking ventilation openings, average wood moisture contents exceeding 30 % dry basis (capable of supporting wood decay and corrosion in metal fasteners) were found after 2-3 months of cold weather operation. Moreover, restricted air movement in these barns inhibited drying and allowed wood moisture contents to remain ele-

vated even into warm weather. Warm, moist conditions favor growth of mold, bacteria and decay fungi and accelerate metal corrosion. The presence of insulation under the roofing in these problem barns fostered this situation.

Even if free water from precipitation and condensation causes slightly elevated moisture contents, adequate air exchange, especially as weather warms, will promote drying of wood truss components so that deterioration will not be a problem.

6.4.3 Misguided use of insulation in cold barns

If insulation is installed under the roof, a potentially cold barn may not be operated and managed as a cold barn. Insulation suggests that the barn is something other than a cold barn and that an available option is to close or block ventilation openings during extreme weather conditions to restrict ventilation. The most serious deficiency associated with this approach is the lack of proper control to restore ventilation rates when extreme weather has passed. Barns with insulation under the roof are often un-

derventilated because evidence of a moisture problem doesn't appear. Besides contributing to problems with animal health, underventilation can lead to the premature deterioration of structural components in buildings. Condensation on the underside of the roof of a cold enclosed barn can be considered a management tool or signal for the farmer that excess moisture buildup is occurring and additional ventilation openings must be provided for better air exchange. The presence of insulation can take away this important indicator resulting in a potentially unfavorable environment.

6.5 Summary

A goal in housing design is to provide an environment for an animal that has a positive influence on the animal's health, welfare and productivity. Essentially, all aspects of the animal's surroundings and activities are taken into account in housing design and management. Environmental considerations include ventilation, stalls and beds, access to feed and water and walking surfaces. Ventilation permeates all aspects of the animal environment.

Chapter 7

Suckler Cows and Calves

7.1 Introduction

During the last twenty years, a number of changes have occurred in the management of suckler cows. These include the concentration of calving period during winter/spring time, the move to the use of feeding of silage instead of hay, the increase of the herd size and the reduction of labour requirements. According to these new tendencies, the design of buildings for suckler cows housing has evolved as well as working practices with the animals.

This chapter tackles the topic of “classic” suckling, which means the timing of calving is during winter/spring, and that the young animals stay with the cows until weaning time. This method of production requires the housing of cows and calves together.

There are several types of housing design, which can be used for suckler cows and calves with the choice depending on a range of factors. This report describes the common systems, which are in practical use. In certain instances it is possible to operate with no housing system and such “open-air systems” constitute an economical solution in some cases even in cold climates because of the rusticity of suckler cow breeds. Such systems are possible with special environmental conditions, and imply for the farmer, the obligation to accept some constraints in his working conditions. This type of production is not a part of this document, which is devoted to buildings for beef production.

Suckler cows can be accommodated in a wide range of housing systems. The main housing systems in common use are :

- Bedded house
- Sloped floor house with bedding
- Cubicle house
- Slatted accommodation

Numerous variations of these main housing types exist in practice.

Before detailing the specific organization of these systems, with their advantages and disadvantages, it is necessary

to speak about the area requirements for the calves, and the size of the groups of suckler cows.

The area requirements for the calves are in a strict relationship with the calving period. An autumn born calf needs more area than a spring born calf, because the calf weight and the calf dimensions are proportional to the housing period duration.

The *table 7-1* gives some examples of area requirements in bedded court and bedded sloped floor systems.

Size of the groups: In the housing facility the herd is typically divided into se-

veral groups for ease of management. Generally, the size of a group is between 8 and 16 cows. For each group of suckler cows, it is necessary to have a creep area to accommodate the calves. The dimensions of the creep area are to be defined according to the number of cows calving at the same period.

7.2 Loose Housing Systems (non-cubicle)

Outline designs are provided for a range of loose housing systems which do not use cubicles. A subsequent section deals with cubicle based systems.

Table 7-1: Space allowance per cow and calf (loose housing systems)

Part of the housing system	Very large cows ~800 kg	Large cows ~700 kg	Medium cows & heifers ~600 kg	Creep area (m ²) (winter and spring calving)	Creep area (m ²) (autumn calving)
Standing area width (m)	4 - 5	3 - 4	3 - 4	-	-
Bedded court (m ²)	6 - 7	5 - 6	4.5 - 5	1 - 1.5	2
Bedded court sloped floor (m ²)	4.5 - 6	4 - 5	4 - 5	1 - 1.5	2
Slatted floor	3.4 - 3.6	3.1 - 3.3	2.8 - 3	-	-

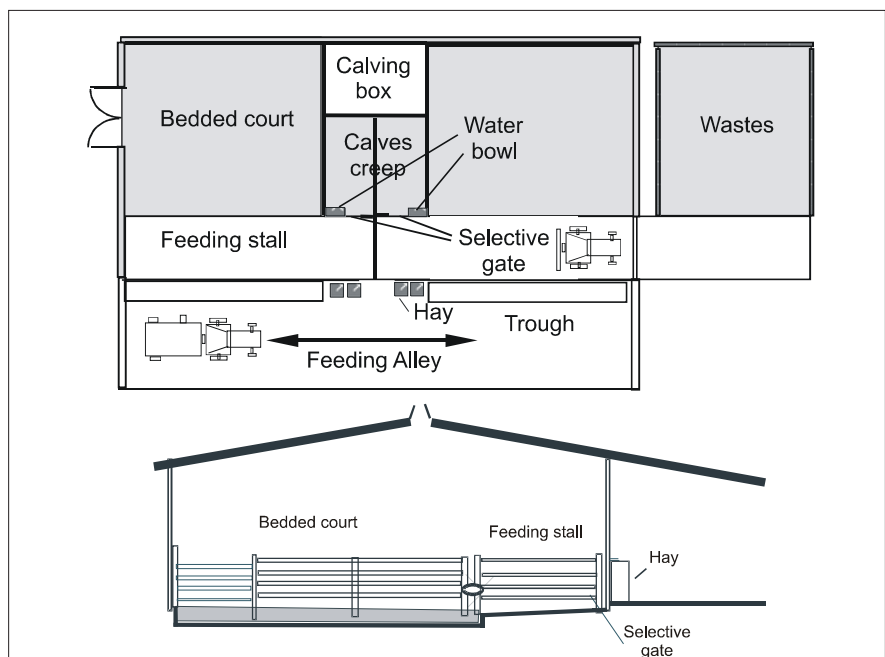

Figure 7-1: Layout and cross section from a bedded house with a concrete exercise court and calves creeps between cow pens

7.2.1 Bedded houses with a concrete exercise court, and calves creeps between cow pens

Feeding:

1. Concrete exercise court of 3.7 m²/cow
2. Possibilities to distribute silage and hay together in the trough
3. Frequent variant: a separated access to the trough for the calves, and no hay rack for the mothers.

Rest area :

1. A number of 16 cows per section, with an area of 6.5 m²/cow.
2. Calves creeps designed in order to have an area between 1 m²/calf and 1.6 m²/calf, with the possibility to use the calving box as part of the calf creep area, when the calving period is finished.
3. A straw requirement of 5 to 7 kg/couple (cow+calf)/day, with an increase to 6 to 8 kg during the calving period.

Ventilation:

Most of the time this kind of building is designed with a free open side along the straw bedded court and is orientated to give this side protection from the direc-

tion of the prevailing wind. If required this open side can be protected with a synthetic wind-break. Such a wind-break should be fixed so that it can be dismantled easily as required in order for example to be able to scrape out easily the manure.

7.2.2 Straw yards and calves creeps between cow pens

Organization of the life area:

1. rest area and feeding alley merged into a mixed-function area
2. an adequate standing stall in order to avoid an excessively dirty area near the trough by spoiling litter too much. This allows to keep clean a theoretical rest area of 6.7 to 7 m²
3. a calving box between the two pens of cows: it can be used by all the calving cows
4. a requirement of 7 to 10 kg of straw per couple (calf & mother) per day
5. a requirement of 10 to 12 kg during the calving period.

Feeding:

The main diet is based on silage, but a small quantity of hay (2 to 3 kg/cow.day) can be distributed in the trough at the same time as the silage.

Ventilation:

Specific requirements: Be careful to avoid a "corridor effect" in the building. Same comments as for 1

A possible variant: bedded court and calves creeps between cow-yards, with a *separate hay rack*

Feeding:

For the herds with a mixed feed (silage and hay), including more than 4 to 5 kg of hay/cow.day, it is practically necessary to provide the hay separately.

Rest area:

In this variant accommodation for the cows is similar to the previous system, but the area for the calves is reduced to only 1.2 m² per calf as calving takes place close to the end of the housing season.

Comments on the disadvantages of that solution of « feeding stall »

The self cleaning function reduces labour requirements as it is not necessary to scrape the area. However, the area requires a sufficient slope to allow the manure to slide down (3 %), and this can possibly lead to the animals adopting a bad posture during the feeding period. Other consequences are: a lot of manure between the area and the bedded court, wet litter, dirty animals and problems with animal health.

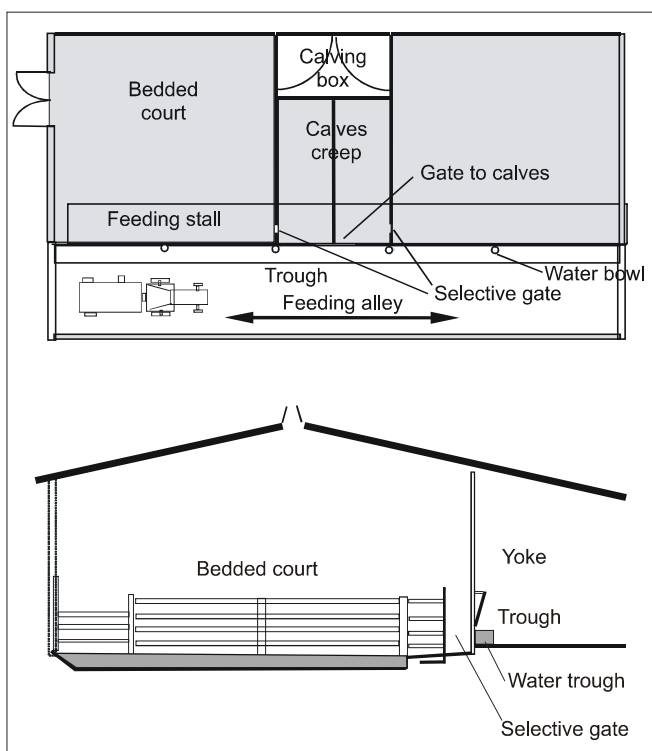

Figure 7-2: Layout and cross section from a bedded house with straw yards and calves creeps between cow pens

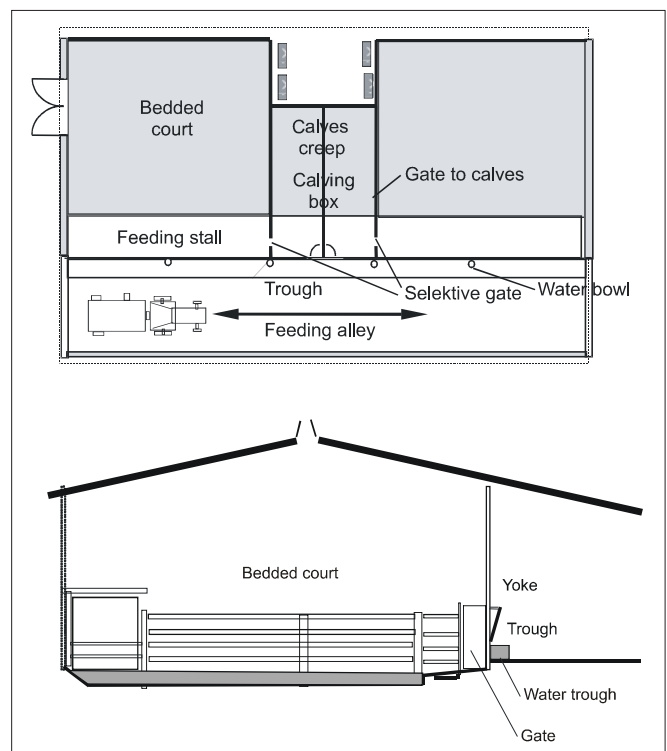

Figure 7-3: Layout and cross section from a bedded court and calves creeps between cow-yards, with a hay rack

7.2.3 Bedded court on sloped floor with calves creeps at the rear part of the straw bedded court

Feeding:

1. Concrete exercise court with an area of 2.40 m² + 1.35 m² for the standing stall, whose secondary function is in simplified systems, the immobilizing of the cows in order to treat the animals. We recommend to have in addition, a specific restraining device to allow some security to the farmer and the veterinary surgeon.
2. Feeding of the calves separated from the feeding of the mothers. The access to the calves creeps is given by the service alley.
3. Watering with a big water bowl on the standing stall.

Rest area:

1. Sixteen cows per pen, with an area of 4.90 m²/cow
2. Calf creeps designed in order to have an area between 1.25 m²/calf and 1.90 m²/calf, with the possibility to use the calving box as part of the calf creep area when the calving period is finished.

3. A slope of about 6 %, which limits the height of the straw bed at a level of 0.30 m.
4. A straw requirement of 4 to 6 kg/couple (cow+calf)/day, with an increase to 5 to 7 kg during the calving period.

A possible variant: bedded court on sloped floor, and calves creeps between cow-yards, with a specific hay rack

Changes in feeding:

1. Hay and silage separated for the cows
2. Access to the trough for the calves with a specific diet, which is easy to distribute in this part of the manger.

Changes for the rest area:

1. A little more surface area for the cows: 5.20 m²
2. A very good system for the regions with a short housing period (less than 130 days), and with a dry climate.

7.3 Free Stalls/Cubicles

Outline designs are provided for a range of loose housing systems, which use cubicles.

7.3.1 Head to head cubicles with calves creeps between cubicles rows

For all the cubicle housing systems, the dimensions to design comfortable facilities are given in chapter 3.

Feeding :

1. Possibilities to give forages separately.
2. Calves feeding independently in the creep areas (access by the extremities)
3. Minimum one water bowl per section.

Rest area :

1. A head to head design with a calf creep area between the two rows.
2. Length of the cubicles ranging from 2.30 m to 2.50 m. It is necessary to put some tubes at the front side of the partitions, not only to fix the partitions, but also to be able to confine the calves in the creep area if required.
3. Straw requirements for the cubicles: a minimum of 0.50 kg/cow.day for animal welfare (synthetic mats can also be used but straw must be preferred if available).

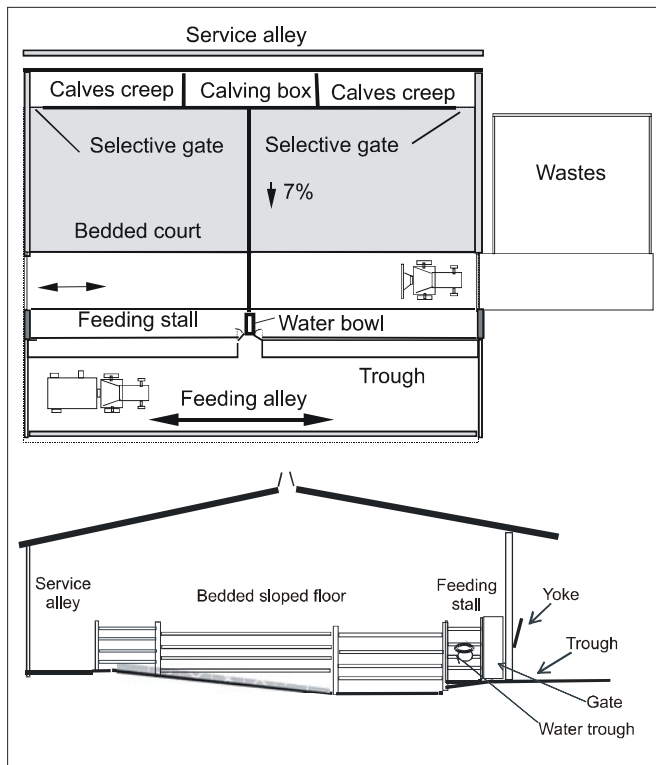

Figure 7-4: Layout and cross section from bedded court on sloped floor with calves creeps at the rear part of the straw bedded court

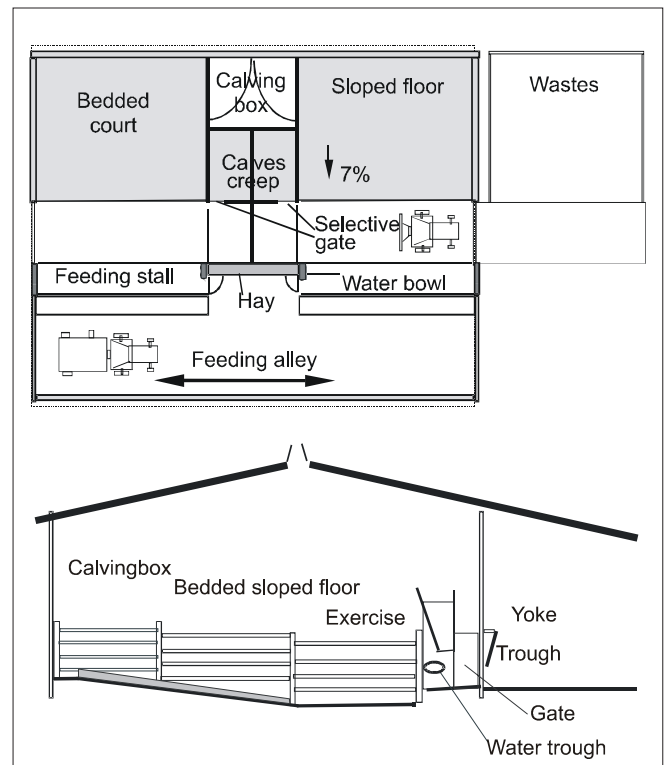

Figure 7-5: Layout and cross section on bedded court on sloped floor and calves creeps between cow-yards, with a specific hay rack

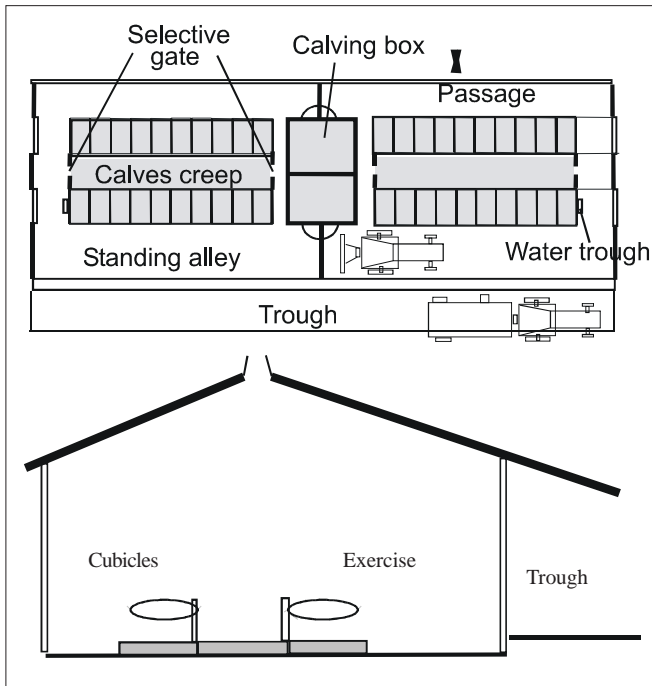

Figure 7-6: Layout and cross section from head to head cubicles with calves creeps between cubicles rows

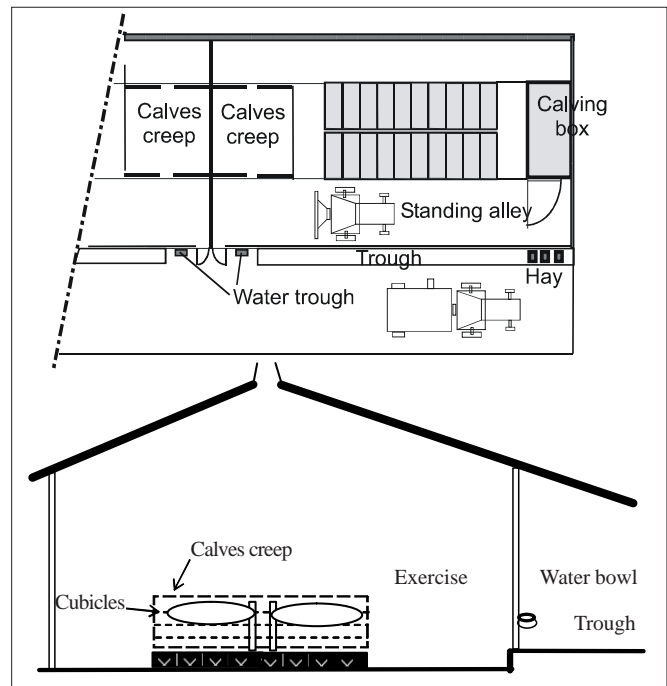

Figure 7-7: Layout and cross section from head to head cubicles with calves creeps and calving box at the side

- 3 kg/cow/day in order to obtain a soft to solid manure
- 4. Straw requirements for the calves:
 - 1 to 2 kg/calf/day for the calves creep
 - 6 to 8 kg/day during calving period for the calving box.

Ventilation :

1. Like in other kinds of buildings, there is very often a free open side. In order to be able to supply easily the hay racks with big bales, the open wall is located at the side of the feeding alley, and not at the opposite side.
2. As previously explained, this free open wall can obviously be protected by a wind-break material, with the same precautions to avoid draughts on the animals.

7.3.2 Head to head cubicles with calves creep and calving box at the extremities.

Changes in feeding :

1. Possibility to give a specific feeding to the calves in front of their boxes.
2. Same possibility for the cows using the calving boxes.

Changes for the rest area :

1. Cubicles shorter than in the variant 4.1 because of the possible crossing of the cow-heads in the front part of the cubicles, designed in a head to head position, each row close to the other one.
2. Limits of the calves creeps and the calving box in the continuation line of the cubicles rows, giving an area

of 1.65 m² to 1.90 m² [depending on the duration (organization) of the calving period].

7.3.3 Back to back cubicles with calves creeps and calving box at the extremities.

Feeding :

Same organization as for the variant 4.2

Rest area :

1. Separation between resting area and feeding area.
2. Length of the cubicles designed like in the case of a front wall (long cubicles).
3. Straw spreading not easy to realize.
4. Frequent need of two calves creeps for each pen.

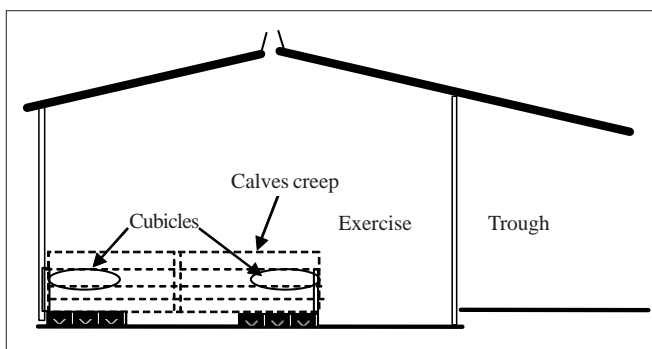

Figure 7-8: Cross view from back to back cubicles with calves creeps and calving box at the extremities

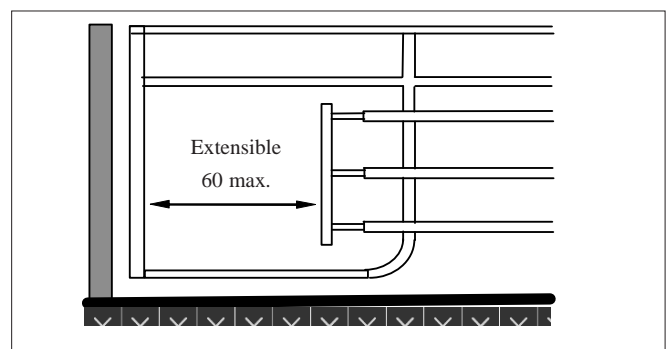

Figure 7-9: Back to back cubicles with calves creeps and calving box at the extremities

Ventilation :

1. One must pay attention to the position of the cubicles row near the wall, exposed to cold draughts coming down from the inlets. The height of these inlets must be sufficient to avoid this risk.
2. The other side, generally free open can be protected by a wind-break material.

Chapter 8

Housing for Calves from Birth to 6 Month

8.1 Introduction

This chapter deals with calves that are weaned (separated from their mother) close to the birth. The calves will be housed either individually or in group according to the management system chosen by the farmer. The individual housing can last for a few days or for several weeks (2 to 8 weeks).

The European Union has taken measures (EEC Directive 91/629, EU Directive 97/2) in which are laid down the minimum terms with respect to housing that are to be met with by farm buildings and their equipment for veal calves.

The most important features of this directives are :

- individual housing is forbidden after the age of 8 weeks, excepted for veterinary reasons;
- the width of individual cage must be equal to the height at the withers and the length equal to the length of the animal multiplied by 1.1;
- partitions between cages must be open to permit sight and tactile contacts between animals;
- for groups of animals, the free area per animal must be 1.5 m² with a live weigh less than 150 kg, 1.7 m² with a live weigh above 150 kg but less than 220 kg and 1.8 m² with a live weigh above 220 kg,
- the stable and the equipment must be built so that each animal can stretch, rest, stand up and groom without any difficulties,
- litter must be provided for animals younger than 2 weeks;
- calves are not tied except in groups only for one hour during the milk distribution;
- if artificial ventilation is used, an alarm system will have to be installed;
- keeping the animals permanently in the dark is forbidden. Natural or artificial lighting must be provided;
- calves must be fed twice a day;

- calves must receive adequate fibre and enough iron in their diet;
- calves older than 2 weeks must have permanent access to fresh water.

This regulation is not enforced on farm with less than 6 calves and where the calves remain with their mothers to receive milk. All the other farms are subject to this regulation. All existing buildings must be satisfied the regulation by 31.12.2006. New buildings for veal calves must be built according to the EU regulation and existing buildings must be adapted to comply with the EU regulations.

8.2 Individual Housing

8.2.1 Hutches

The hutches are frequently made from a synthetic opaque material to prevent the green house effect inside the hutch (heat stress) and from reflective material (light colour material) to reflect sun rays that might otherwise overheat the inside part of the hutch. They may also be built in wood, panels, plywood.

The opening must not be oriented in the direction of the prevailing wind, considering dominant wind direction and rainfall. In many areas of Western Europe a south-east orientation is most suitable.

Generally, the size of the hutches is as follows : length 2.0 m, width 1.5 m (+/- 3 m²), height 1.5 m. In addition, the hutches have an outdoor run of more than 2.0 m² surrounded by either metal wire netting or by welded tubes. There is also a milk bucket support, a dry feed recipient support and a hay rack. Litter may be provided as straw, wood shavings, sawdust, newspapers, ... and should be thick enough to provide a favourable lying environment. It must be dry and clean. Litter must be removed immediately after the calf has left the hutch.

Hutches should be placed on well drained ground according to the water legislation. This may mean placing on soil with a sand layer of 15 cm. After use, the sand should be removed to suppress the risks of contamination or on concrete

floor. If the hutches are placed on concrete to make cleaning and disinfecting easier, it is necessary to collect urine and disinfectant in a storage facility to prevent the pollution of the environment and to respect the local regulations.

If the weather is hot, it will be advisable to shade the hutches in order to avoid the negative effects of high temperatures. During the winter it could be useful to take measures to prevent the consequences of very low temperatures

8.2.2 Pens

A nursery is a part of a building, which is exclusively reserved for newborn calves. It is recommended to put the calves into individual pens until weaning.

Individual pens are either dismantlable or made from hard material with concrete walls.

Dismantlable pens are either bought from a tradesman or made by the farmer himself with plywood panels for the walls and hardwood (tropical wood) for the (perforated) floor, which is covered with a litter (thick enough, dry and clean). Bucket supports are provided for on the front. It is recommended to prolong the partition between two pens to the front part to reduce disease transfer from nose-to-nose contact.

The 0.90 - 1.00 m x 1.50 - 1.60 m pen can be put 300 mm above the ground with a view to draining and the removal of

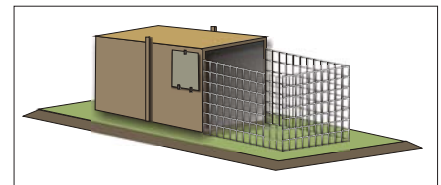

Figure 8-1: Calf hutch

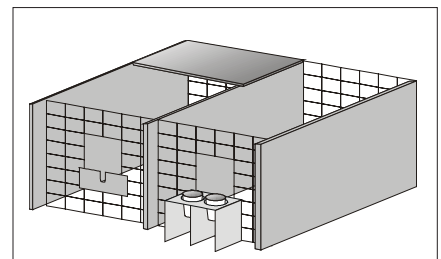

Figure 8-2: Individual calves pen

urine, and to allowed regularly cleaning of the floor during occupation. In cold barns, the thickness of the litter must be increased to prevent draughts around the calves.

8.3 Group Housing

Group housing gives the opportunity to calves to learn living with comrades and to develop relationships with other animals. It also gives the possibility to the calves to increase their immunity against a wide range of micro-organisms.

8.3.1 Collective hutches

The collective hutches are designed typically to house a group of between 2 and 6 calves. The hutches are made of synthetic materials or wood and have, for example, for 4 calves an indoor area of 10 m² and an outdoor run of 10 to 15 m².

The inside of the hutch is provided with litter and some hay may be put in a rack. Roughage is distributed at a feeding barrier and anti-freeze drinking device is recommended.

With collective hutches fastened on concrete, the outdoor run should have a non slippery surface. The outside run must be cleaned 1 - 2 times a week. Manure and spent bedding have to be removed manually or the collective hutch has to move over a few metres distance by means of a tractor and guide-blocks.

8.3.2 Bedded sloped floor

Sloped floor systems are not recommended for calves younger than 6 months.

8.3.3 Straw yard with bedded lying area

These facilities will be extremely suitable for young animals if sufficient straw and proper ventilation is provided.

If the calves stay there for several months it will absolutely be necessary that a passage on slippery free concrete is provided that their hooves remain strong and wear out regularly. Moreover the floor of this passage should be quite rough to prevent slipping.

With respect to labour costs the concrete floor may be replaced by a slatted floor provided that the spacing between slats agrees with the age of the animals and the local regulations.

Table 8-1: Characteristics of pens for group housing

Duration of stay	Fully bedded (m ² /calf)	Lying area and passage on concrete or on slatted floor		Trough length per calf (m)
		Lying area (m ² /calf)	Depth of the passage (depth in m)	
Until weaning	1.6	1.2	1.0	0.35
From weaning to 3 - 5/6 months	not recommended	2.5 - 2.8	1.2 - 1.5	0.45

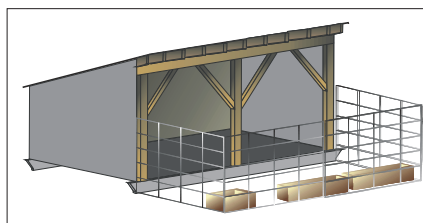

Figure 8-3: Collective hutch

8.3.4 Cubicle house

Cubicles are not recommended for calves younger than 6 months.

8.3.5 Fully slatted floor

Concrete fully slatted floors are not recommended for calves younger than 6 months.

8.4 Tied Stall Barn

Tying stalls are forbidden by a EU directive and are not recommended in the countries where they are not forbidden.

8.5 Veal Calves

As mentioned in point 8.1 Introduction, in the European Union, regulations have been adopted to improve the housing conditions of veal calves according to the wishes of groups of persons dealing with animal welfare.

8.5.1 The new buildings

The new buildings must be equipped to house calves in groups. The calves are fed manually with a hose or by an automatic milk feeder.

In the case of manual feeding, the calves are housed in groups of 8 to 10 and they are fed twice a day. There are partitions in the front of the pen to avoid situations in which one calf drinks the milk of other calves. In the front of the pen, cages can be placed to maintain the calves separately during one hour after the distribution of milk to prevent comrade suckling. After one hour the calves are free to move around.

In the case of automatic milking feeder, the calves are housed in groups of about 30.

The calves can be housed on a bedded court (straw on the whole pen or straw for the lying area and concrete or slatted floor for the rest of the pen) or on a fully slatted floor (wood, concrete or concrete covered by a rubber). The required surface depends on the weight at slaughter. For calves slaughtered at the weight of 180 - 200 kg live weight the surface requirements are at about 1.7 - 1.8 m² per animal in the EU regulation but are frequently increased to 2.8 m² per calf.

8.5.2 Existing buildings

In existing buildings, the single pens are replaced by group pens that are put on the place formerly occupied by the single pens and by the passage between the pens and the wall; as a result each calf gets an area of approximately 1.9 m² which is larger than the requirements of the EU regulation. The front doors of the single pens are replaced by a feeding barrier especially made to supply the liquid milk replacer in buckets. Each calf has a feeding place of about 0.72 m.

The calves are brought together in groups of 8 to 10. Partitions between the calves can be placed in front of the pen to improve the distribution of the milk replacer.

There must be a sufficient supply of daylight so that the animals may see each other and be watched by the farmer. If necessary provision for light entry must be made in the walls.

The wooden slatted floors (hard wood) are replaced by concrete slats covered with rubber mats of the same shape or by a new wood slatted floor.

The artificial ventilation must be adapted to obtain an optimal air quality.

8.5.3 Veal calves and automatic milk feeder

Automatic milk feeding systems are increasingly being used for veal calves. Each automatic milking feeder is made to manage 2 milking dispensers, and each milking dispenser can be used for about 30 fattening calves. The calves are assembled so as there is a limited age difference between the animals so as to prevent hierarchic and health problems within the group. Calves remain together until slaughter and they receive milk replacer according to their needs or ad libitum. If calves are fed according to their needs, they will be identified by the system by means of a collar with a transponder or by means of a transponder inserted in an ear tag or injected under the skin.

8.5.4 Type of lying area and ventilation

Natural ventilation and cold housing are recommended for raising calves. In some cases (calves on fully slatted floor) warm housing is the most suitable system to provide a good environment to the calves and to prevent diseases and mortality.

Bedded pack

For calves housed on a deep litter of straw (bedded pack, 2.3 to 2.8 m² per calf) cold housing is the recommended system to provide a good environment to the calves. An open front with adequate orientation based on prevailing wind and exposure to the sunrise is recommended. Movable curtains on the opposite wall are

necessary to prevent drafts during the cold months and heat stresses during the summer. An insulation of the roof is not required.

Slatted floor

For calves housed on a fully slatted floor, warm housing, heating and mechanical ventilation are necessary to provide a good environment to the calves. Insulation of the walls and the roof, heating during the cold months and mechanical ventilation are required to prevent too low temperature of the air and too high relative humidity of the air.

During the hot days, mechanical ventilation and thermal insulation help to maintain a normal temperature in the housing.

Chapter 9

Housing for Finishing Animals

9.1 Introduction

The provision of accommodation systems for finishing beef animals is essential for efficient herd management. The type of housing provided will depend on a range of factors including geographic location, availability of straw, size of the unit and on the traditional methods of fattening in the particular region. Depending on the finishing system animals may remain in the house until slaughter or return to pasture following the winter period. In the latter case these animals may be finished outside or spend a subsequent period in the accommodation prior to being slaughtered. Loose housing systems predominate for beef cattle. When designing accommodation facilities for fattening cattle consideration should be given to labour availability, feeding system, type of diet, group size, drinking system, and facilities for handling and storage of the manures produced. The requirement for housing during the finishing period may be due to land conditions that do not facilitate outdoor feeding due to soil type and climatic factors. In certain situations housing is provided to facilitate the structured feeding of the animals under controlled management conditions. Also, housing facilities should provide a suitable working environment for the farmer and any employees involved in taking care of the animals.

9.2 House Types

Traditionally, beef cattle were housed in straw bedded facilities. The unavailability of straw in some areas (combined with its increased cost), the need to reduce labour requirements and the necessity to ensure manure was efficiently managed to avoid pollution risks, has encouraged the development of housing systems utilising liquid manure storage. Variations in the design have evolved including houses with partially slatted floors, houses with sloped floors inclining towards narrow slurry channels and houses with slats over shallow tanks from which the slurry flows by gravity to an adjacent storage facility. Cubicle houses

can also be used for finishing animals where no straw is available but such facilities are not recommended for male animals because, they foul the lying area with urine. Where straw is available for bedding typical systems include fully bedded pens, facilities with bedded lying areas and solid unbedded or slatted feeding stands and facilities with sloped floors, which depend on the animals to move the fouled bedding down the slope for collection. Tethering of animals in stalls is still used as a management system in some beef units but this method of housing is not recommended.

9.2.1 Bedded house

Such houses consist of bedded pen(s) with the total living area covered in bedding material, which normally is straw. The facilities are roofed but are sometimes referred to as “straw bedded yards”. Cattle should be housed in groups of not more than 20 to aid management. This type of house requires 4 to 6 kg of straw per animal per day which equates to approximately 1 (metric) ton straw per animal for a winter housing period. The completely bedded system does not prepare the hooves of the animals for subsequently walking on harder surfaces such as concrete. Sometimes the hooves may become overgrown and misshapen, which may lead to lameness problems. Although the systems are relatively cheap to construct the high straw require-

ment with associated labour costs must also be taken into account when making comparisons with other systems. The manure/bedding mixture is allowed to build up over the housing period and is normally removed once at the end of the season. Depending on the length of the housing season the accumulated material may rise up to greater than 1m above floor level. It is necessary to take this into account when installing gates, partitions and feeding barriers & troughs. A typical layout of such a facility is presented in *Figure 9-1*.

9.2.2 Bedded house with concrete or slatted feeding stand

In this type of facility the animals come to feed on an area of solid concrete or an area covered with slats. In the case of solid concrete the area is cleaned by an electric, hydraulic or tractor powered scraper. Where a tractor is used additional gates are used to close off the feeding stand from the bedded area during cleaning. The design has the advantages that lower quantities of straw are required and that the geometry of the feeding stand does not change as the manure builds up over the housing period. Straw usage is in the order of 2 to 3 kg per animal per day. However, both a liquid and solid manure is also produced with the system. If slats are used in the feed stand it is important to minimise the quantity

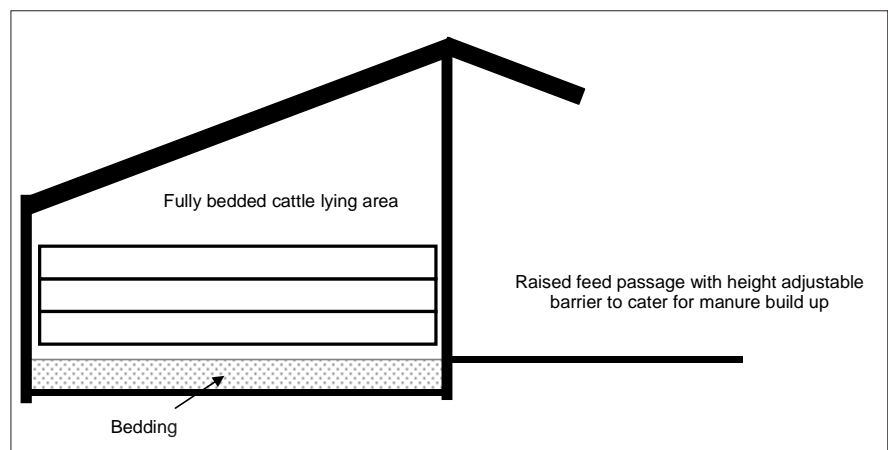

Figure 9-1: Straw bedded facility cross-section showing raised passageway

of straw entering the tanks to avoid problems with slurry agitation. A cross sectional view is shown in *Figure 9-2*.

9.2.3 Bedded house with sloped concrete floor

This housing system involves the frequent removal of manure but daily straw requirements can be as low as 1 to 3 kg per animal per day. The floor is laid with a slope of 5 to 10 %. The system operates on the principal that the movement of the animals will transfer the manure down the slope where it is removed by scraping. A cross section of a typical layout is shown in *Figure 9-3*.

9.2.4 Cubicle house

A cubicle house provides an animal with an individual safe lying area. The system is widely used in the dairy industry for cows and the house type provides a clean lying area without the requirement for bedding material. Sometimes a little straw is used on the beds, which are normally constructed with concrete. Artificial mats are widely used in the dairy industry to improve the lying environment in cubicle beds. Major limitations with cubicles for beef finishing animals are:

- the fact that as animal size is changing it is difficult to optimise the dimensions of the cubicle
- male cattle foul the cubicle bed with urine
- animals may only be housed for a relatively short period e.g. one winter season and often it is difficult in these situations to train animals to use the facilities

9.2.5 Slatted floor house

The development of housing systems for beef animals utilising liquid manure storage has been promoted in order to overcome the unavailability of straw in many areas (combined with its increased cost), the need to reduce labour requirements and the necessity to ensure manure is efficiently managed to avoid pollution risks. The majority of such systems use concrete slatted floors with the liquid manure or slurry falling through the floor perforations into a below ground concrete tank. The depth of the tank is such so as to provide adequate waste storage capacity for the housing period and is now typically about 2,5 m. A central covered

feeding passage is typically used with confinement pens on each side. Silage can either be fed independently from concentrates or in combination. Feed face length is typically 0.3 m per adult animal for silage only feeding; 0.45 m where complete diets are fed and 0.6 m where concentrates are separately fed from silage.

The ratio of pen depth to width can be manipulated at the design stage to ensure adequate lying area and feeding space is provided. The superstructure is typically constructed from steel stanchions, steel trusses and timber purlins. Portal frame configurations are also used. Roof sheeting and cladding is typically galva-

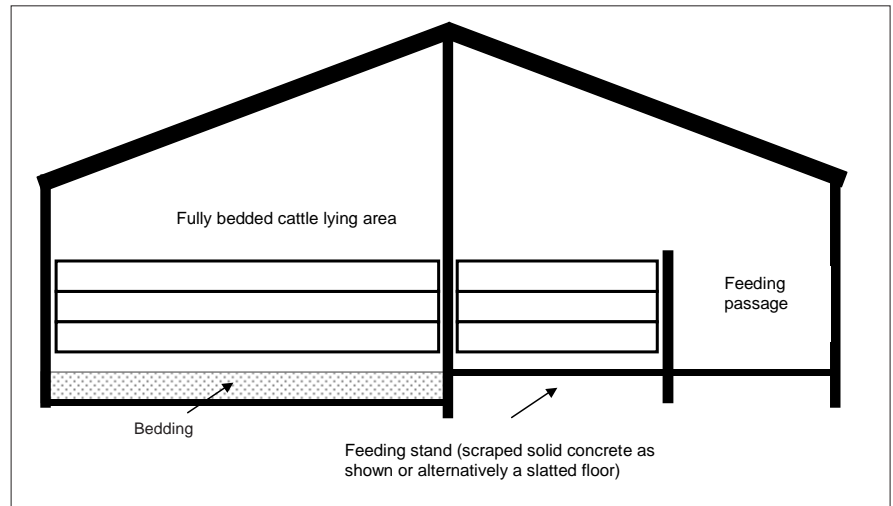

Figure 9-2: Bedded house with concrete feeding stand

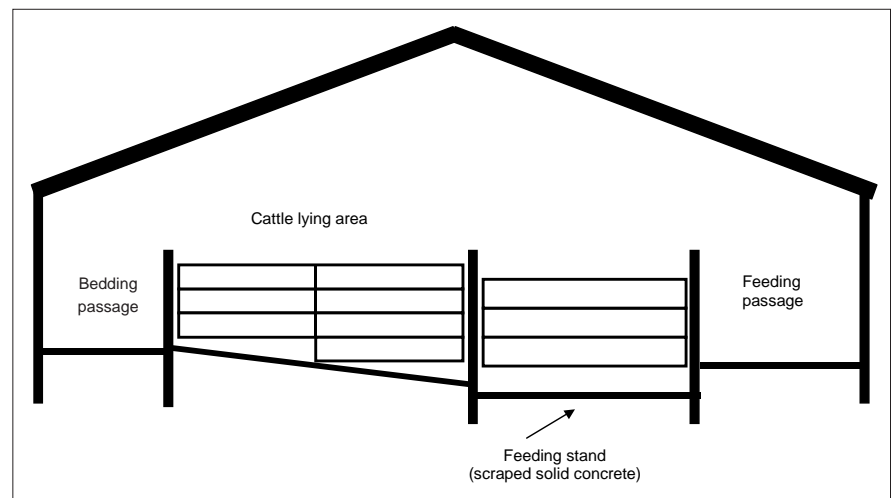

Figure 9-3: Bedded house with sloped concrete floor

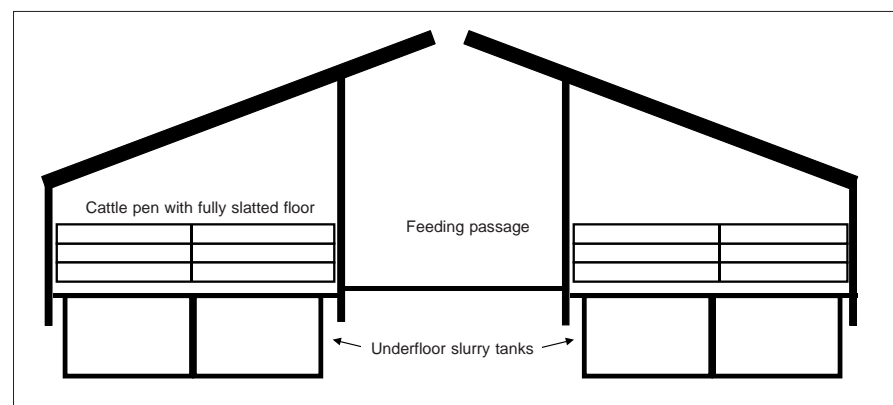

Figure 9-4: Cross section of slatted floor house

nised steel or fibre cement sheeting. Ventilation openings are provided at the sides of the building and at the ridges. The size of the opening is dictated by the exposure of the site. More recently spaced roof sheeting has successfully been used and it has the advantage in that it provides a more uniform removal of stale air from over the animals throughout the buildings. To improve the interface of the floor with the animal the ribs of the slats can be covered with rubberised materials to provide cushioning for

the animals. A cross sectional view of a typical unit is shown in *Figure 9-4*.

9.2.6 Sloped floor system without bedding

This design is based on solid floors, which slope towards narrow manure collection channels covered with slats. The optimum length of the sloping floor section to avoid manual cleaning is approximately 1.5 m. The slope should be 1:12 (8 %). The manure channels should be 300 mm wide and at least 300 mm deep

and up to 450 mm deep for long channel runs. A flushing system or mechanical scraper can be used to effectively remove the manure from the channel to an outside storage facility. While the system offers the advantages of the slatted system (no straw costs and effective collection and management of liquid manure) the animal's hides will be dirtier, resting behaviour of the animals disturbed and the risk for pressure injuries on the animals will increase with this design of facility.

Chapter 10

Safety and Animal Handling

10.1 Introduction

Stockmen working in animal housing and associated handling facilities are exposed to a number of potential risks and health hazards. Many stockmen work alone, handling big, sometimes dangerous animals as well as large groups of animals. Several work tasks involve daily lifting, carrying of heavy loads and awkward working postures, which may cause overload injuries on the worker's musculoskeletal system. Other potential risk factors contributing to accidents as well as to physical health problems and physiological stress for the worker is the fact that they operate in an environment where they are exposed to airborne particles, gases, noise. The work environment is partly the same environment, which is provided for the animals, and it should be noted that there is a strong relationship between the animal welfare issues and the handling of the work environment problems in cattle houses.

10.2 Health and Injuries Among Livestock Farmers

10.2.1 Accident agents

In an accident situation there is a complex interaction between man and injury agents. In animal husbandry the human is subjected to a high degree of exposure to a large number of factors that singly or in combination can be accident provoking, such as animals, equipment and building structures. Risky situations are often due to wet and slippery floors as well as systems for material and animal handling.

10.2.2. Prevention of accidents

With reference to accident statistics some accident preventing facilities and measures can be listed:

- Good cattle handling and handling facilities (Section 10.3)
- Pens from which the herdsman can easily escape if necessary in case of for instance frightened cattle and aggressive bulls

- Personnel passages through yard fences, properly placed
- Wide feeding passage or possibility to shut out the cattle from the feeding area
- Non slip flooring (see Chapter 4)
- Satisfactory lighting considering quality and quantity (Table 10-1)
- Well designed ladders and stairways
- Protective railings around the fodder hay-chute in two storey houses
- Handles and bolts that do not stand out in alleys and pathways
- Protectors for the knuckles on barrows
- Emergency stops on machinery

Table 10-1: Recommended illumination level for different work areas in buildings used for beef production. Lux values refer to the work plane. In addition to the quantity, the quality of light (i.e. colour of the light source, uniformity of illumination and glare) must be considered

Building or work area/Task	Intensity of illumination, lux
Animal housing area	150
Animal handling area	250
Veterinary treatment	1 000
Feed processing, feed alley	250
Silo, feed storage	100
Ladders and stairs	250

10.2.3 Ergonomics

Any normally fit adult person, regardless of sex, physical strength and body dimensions should be able to work comfortably in livestock buildings. Despite an increasing degree of mechanisation and automation many jobs in animal husbandry are still associated with lifting heavy loads, moving and carrying equipment, feed and other materials with manual methods. An important step towards improved human welfare within cattle housing is to eliminate unnecessary loads on the human musculoskeletal system.

10.2.4 Health aspects related to air quality

It has been known for decades that farm workers suffer health risks due to inhala-

tion of gases and airborne particles commonly referred to as dust. The particles may be liquid droplets or solid. Several respiratory disorders have been reported, which are associated with dust and work in confined livestock buildings such as hypersensitivity, pneumonia, acute inflammation, chronic bronchitis, occupational asthma and toxin fever. The respiratory problems connected to gases range from mild irritations of the respiratory tract to lethal effects. For the most frequent components in the air environment in livestock buildings there are statutory threshold limit values, which differ from country to country.

It should be noted that threshold limit values in connection with animal welfare in many countries often are lower than the work environment legislation.

10.2.5 Dust and dust reducing

Dust in animal houses is generated inside the building and arises primarily from the animals and bedding and feed material. The airborne particles are often carriers of biologically active material like endotoxins, pathogens and allergens that can highly be disease provoking. Of special interest is the concentration (i.e. number of particles per air volume) of respirable particles with a diameter less than 5 µm that can be inhaled and deposited in the lung. The smaller particle the higher possibility that the particle reaches the lower respiratory tract and the deeper the particle is deposited the higher is the risk for illness. Even if "common dust" can be seen by human eyes (larger diameter than 100 µm), the very small respirable particles cannot be, so we are indeed dealing with a danger our senses are not able to detect.

There are basically four approaches that can be used for airborne dust reducing:

- Prevent particle formation
- Prevent particle release
- Remove suspended particles from enclosed workspaces
- Isolate workers from dust clouds in workspace.



Of course the best approach in this matter is to have the cattle and the working sites outdoors or in open barns. In the cattle barn the most effective way to obtain a low dust concentration level is to prevent formation by always using hygienically perfect forage and bedding material. Providing an effective ventilation system in a barn is a good practice to remove suspended respirable particles as well as gases.

10.2.5 Gases and reduction of gas levels

In animal buildings over 150 different gases and volatile compounds have been identified. Most of the volatile compounds originate from biodegradation of animal excreta or are produced by the animals themselves such as carbon dioxide (by the respiration of the animal). The gases that are found in the highest elevated concentrations are ammonia, carbon dioxide, hydrogen sulphide and methane. ***It must be emphasised that it is dangerous to enter any manure tank*** without either using a self-contained air supply or combining several measures: testing the air, constant and adequate ventilation of fresh air and using an harness and lifeline on the person entering the tank. As well, human and animals positioned over a slatted floor with manure storage underneath are at risk during agitation, mixing or pumping of manure due to the gases, especially hydrogen sulphide. A good strategy is to evacuate dangerous zones during these manure-handling actions.

Ammonia: Ammonia is the most common polluting gas in the atmosphere of the cattle barn. Animal manure is the main source of ammonia. The gas together with hydrogen sulphide a major component in what is termed odour, noticeable at ammonia concentrations of 5 ppm or more. Higher concentrations than that cause irritation to the respiratory organs and can aggravate the negative health effects of high dust concentrations.

Many factors affect the emission and concentration of ammonia such as air flow rate, manure and air temperature, manure surface area, density of animals, the degree of mixing of urine and faeces, time intervals between manuring, the pH-value, carbon/nitrogen ratio, moisture content and type of bedding. Consequently,

many measures can be taken such as: proper ventilation and sufficient number of air changes, low air temperature in the barn and good urine drainage characteristics of the floor.

Hydrogen sulphide: Hydrogen sulphide is the most toxic gas in animal confinement houses and 200 ppm and more are lethal for humans. The presence of the gas is of concern in buildings with liquid manure systems particularly. During slurry clearing operations concentrations in the range of 1 500 to 2 000 ppm have been reported.

Since hydrogen sulphide is lethal the aim should be to keep it below detectable concentration at all working sites. Special care has to be taken when pumping or agitating the manure. During emptying a slurry cellar the workers and the animal should be evacuated from the barn. In mechanical ventilated, closed animal houses continuous evacuation of the gases in an indoor slurry pit through a perforated duct under the floor and along the pit can reduce the gas concentrations above the slatted floor. By removing the slurry daily from the cattle barn to an outdoor storage it is possible to hold the concentration at an acceptable level.

Methane: Methane is generated when manure is stored under anaerobic conditions. This occurs in all non-aerated manure storages. Primarily, methane is dangerous because of its flammability. If methane is mixed in a proper proportion with oxygen a spark will be able to set off an explosion.

Carbon dioxide: Carbon dioxide is present in all air, indoor as well as outdoors. Only extremely high concentrations (70 000 ppm or 7% and over) could have severe health effects. Mostly, incidents and accidents involving carbon dioxide are connected with asphyxiation due to oxygen deficiency rather than the direct effect of carbon dioxide itself. For instance, it is dangerous to enter a haylage silo during storing. In animal buildings the gas is more an indicator of ventilation efficiency than a health risk.

10.2.6 Noise

Noise can be defined as "unwanted sound, rapid, annoying pressure vibration in the surrounding air". Ventilation fans, grinders, vacuum pumps and mechanical feeding and manure systems

generate noise. High sound levels are a real stress factor. Exposure to noise will be able to cause temporary deafness and permanent hearing loss after a variable period if the level is over 85 dB(A). The unit, dB(A), is exponential and the human sense of hearing will perceive the sound level as halving if a reduction of 10 dB(A) occurs. It is fairly easy to reduce the sound level of ventilation fans and other mechanical noise generators. Maximum noise level recommendations and regulations differ from country to country.

Furthermore, it is important to reduce noise when handling cattle in order to improve animal movement and to make cattle handling safer. Cattle are more sensitive to high frequency noise than human. Animals will be calmer and easier to handle, if noise level is reduced. Clanging and banging metal parts should be silenced with rubber pads. Equipment operated with hydraulics should be engineered for quietness.

10.3 Cattle Handling and Cattle Handling Facilities

Handling facilities are an essential part of a safe, easy and rapid handling of cattle. Appropriate handling and handling facilities remove much of the stress and frustration of the workmen, which inevitably occurs with excited, stubborn or aggressive animals. Properly constructed facilities confine cattle safely and efficiently with minimal animal stress and risk of injury to both cattle and workers.

10.3.1 Animal behaviour and improving animal handling

Understanding cattle behaviour can help farm workers to avoid dangerous situations and minimise accidents to handlers, as well as to design the handling facilities appropriately. Animals have natural boundary called the Flight Zone (*Figure 10-1*). Deep penetration into the Flight Zone can cause panic and escape attempts. Handlers should have the possibility to remove, and should remove themselves from the Flight Zone, if the animal becomes aggressive.

To move an animal forward: stand in the shaded area position B, behind the Point of Balance at the shoulder. Keep out of

the Blind Spot at the rear of the animal. To stop movement: back off to position A. To make an animal back up: stand in front of the Point of Balance. To make an animal turn left or right: approach the animal head on. Factors reducing an animal's Flight Zone size: frequent contact with people; history of gentle handling; calm environment. Factors enlarging the Flight zone: infrequent contact with people; history of rough or abusive handling; excitement.

To improve animal handling and animal movement, many technical measures can be taken such as:

- Appropriate handling facility design (Section 10.3.2).
- Animals tend to move from a dark to a more brightly lighted area. The light should illuminate the chute up ahead. Eliminate shadows and patches of light and dark, which may confuse animals. An approach is to illuminate the entire working area. Lamps should not shine into the eyes of approaching animals because glaring and blinding light impedes movement. Illumination should be uniform and diffuse.
- Prevent distractions, such as a chain hanging down in an entrance. Avoid sparkling reflection in a puddle, a moving reflection on a sheet of metal or bars of shadow across an otherwise sunlit alleyway. Dark colours can create shadow effects. Bright colours such as white and light yellow have been proven satisfactory.
- Reduce noise (Section 10.2.6)

- Animals might refuse to move, if they can see people ahead. Install shields to prevent animals from seeing farther ahead. Gates can be rigged with motor controls so a handler standing behind the cattle can open them.
- Solid sides that prevent the cattle from seeing outside the fences should be provided in the races and crowding pens. The crowding gate on the crowding pen should be solid as well, preventing animals from attempting to turn back to where they come from.
- Cattle are sensitive to changes in type and texture of floors and fences. Changes in type of flooring can cause balking. Use the same type of flooring throughout a facility, if possible. Use non-slip flooring. Drains should be located outside main drive alleys, chutes and crowd pens.

10.3.2 Cattle handling systems

A handling system has three main purposes: to sort, handle and treat cattle. The parts and the requirements of a system are (Figure 10-2):

- **Collection alley** to move cattle from the cattle house, pasture or feedlot to the holding pen
- **Sorting pens.** Opening off the collection alley or holding pens, or after the working area
- **Holding pens** to hold either the whole herd or groups of 30 -50 heads
- **Crowding pen** to move small groups of 8 – 10 cattle into the working area

- **Single file race**, at least 6 m long to hold 3 – 4 cattle at once
- **Loading chute**
- **Crush**, preferable type “walk-through” and with a self-locking head-gate
- **Options** such as scales, calf crush or table, belly clipping crush, crush equipped for claw-trimming, access kiosk for artificial insemination and gynaecological examinations, shelf near the crush for veterinarian's equipment and materials, the availability of hot and warm water near the crush

The current trend in the design of cattle working facilities is to use circular crowding areas and working chutes (Figure 10-3). The circular designs take advantages of cattle's tendency to circle and crowd towards the outside of a curved passage. Cattle can normally be worked in less time with a round crowding pen and a curved race than a straight one. Round crowding pens should be laid out so the cattle make a 180° turn as they move through the crowding pen.

However, a straight-line designed (Figure 10-5) as well as a corner located working unit (Figure 10-7) are area saving alternatives, especially valid for small herds of cattle and indoor, respectively.

Some corral and working facility dimensions are given in table 10-2.

Some facilities and detailed solutions improve the human safety in cattle handling systems:

- **Catwalk** around the crowding pen, and working and loading chute allows the

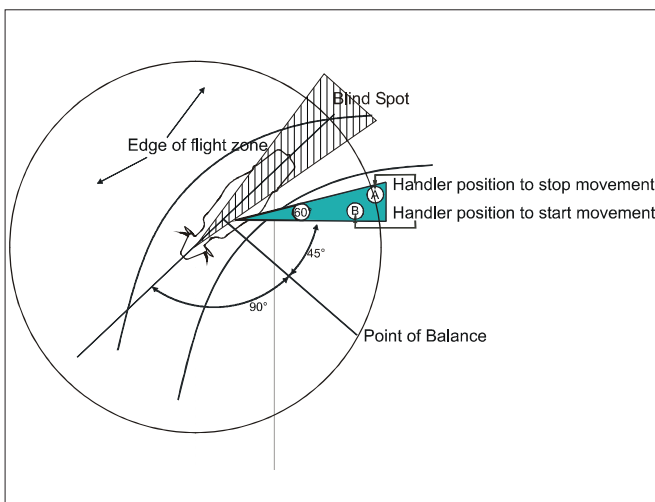

Figure 10-1: The flight zone of animals (GRANDIN, 1999a).

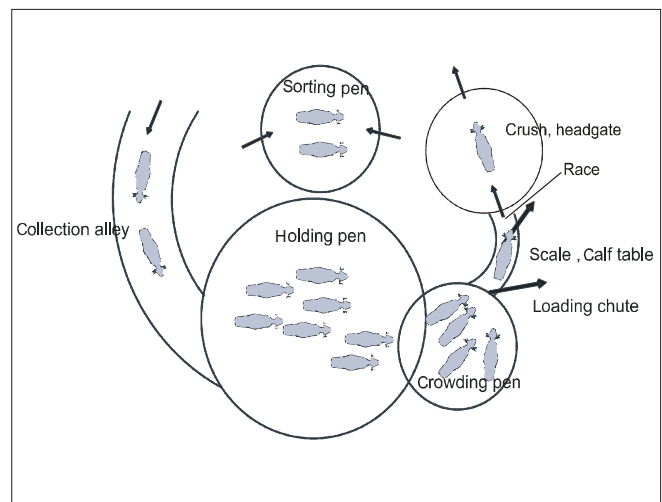

Figure 10-2: Components of a cattle-handling system (BORG, 1994).

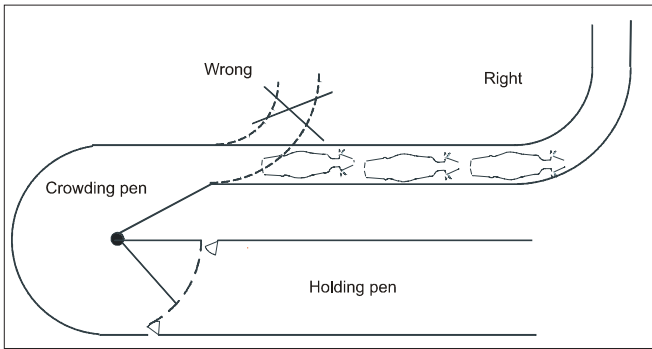

Figure 10-3: Layout for a curved handling system. If the single file race is bent too sharply where it joins the crowding pen, the cattle may refuse to enter, because it looks like a dead end. Cattle standing in the round crowding pen must be able to see a minimum of three body lengths up to the single file chute before the curve begins (GRANDIN, 1999^b)

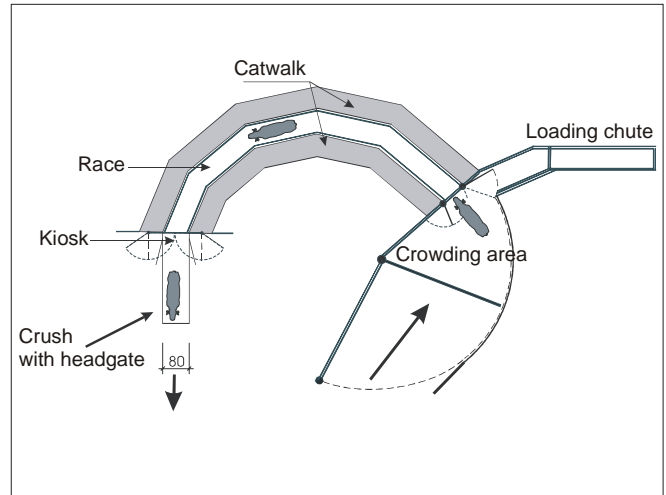

Figure 10-4: Basic Layout for a working unit

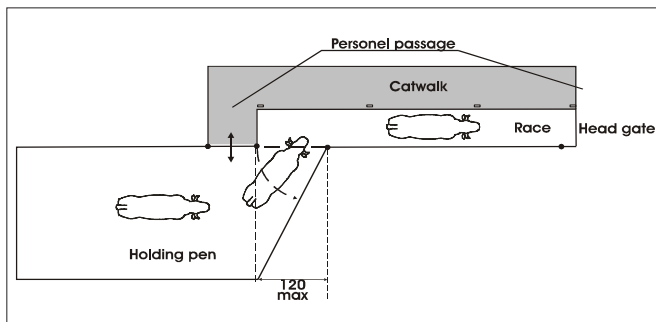

Figure 10-5: A straight-line designed working unit (Institut de l'Élevage & Mutualité Sociale Agricole, 1993).

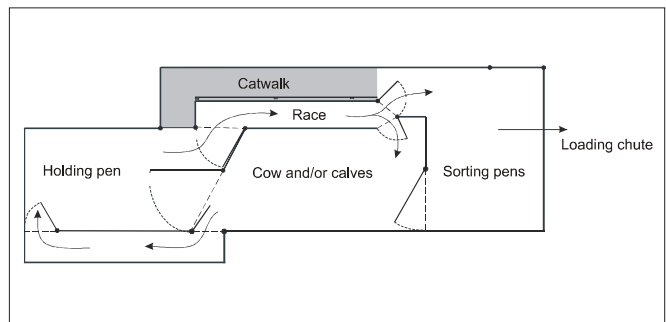

Figure 10-6: A sorting unit, for instance for a suckler herd (Institut de l'Élevage & Mutualité Sociale Agricole, 1993).

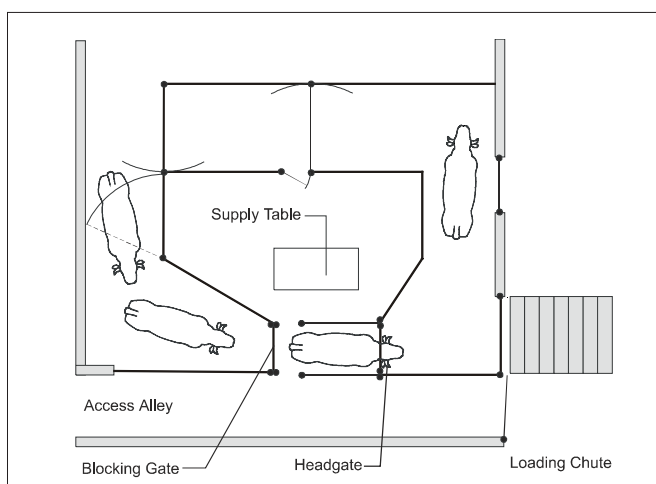

Figure 10-7: A corner located working unit (BICKERT et al., 2000)

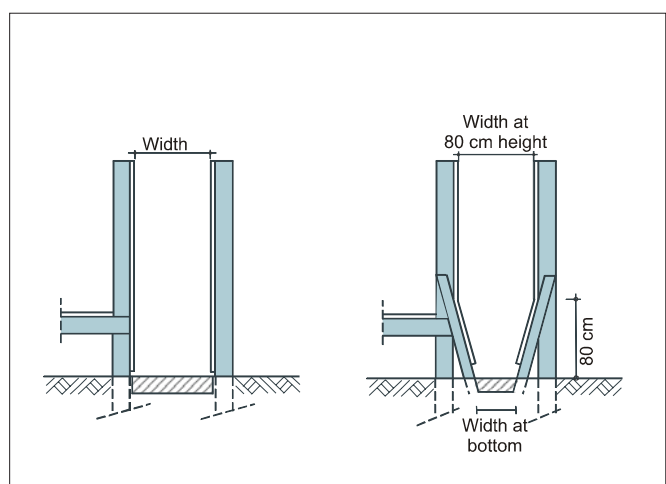

Figure 10-8: Straight sided (left) and half tapered (right) race design. The width, the width at 80 cm height and width at bottom are given in table 10.2., Tapered race allows working with different animal size, but involves risk to get stuck if animals lie down in the race.

Table 10-2: Corral and working facility dimension. L, W and H, respectively in the equations correspond to body dimensions of beef cattle according to Chapter 3. Dimensions of facilities related to animal size are calculated from CIGR standard (Table 3-1)

Equation	Animal Size, kg						
	200	300	400	500	600	700 ^a	
Pen Space							
Holding pen, held overnight, m ² /head	$HA_{on} = 6 * L * W$	2,4	3,1	3,9	4,6	5,2	5,9
Catch or holding pen ^b , m ² /head _{2,3}	$HA = 2,3 * L * W$	0,9	1,2	1,5	1,8	2,0	
Crowding pen, m ² /head	$CA = 1,4 * L * W$	0,6	0,7	0,9	1,1	1,2	1,4
Race with vertical sides							
Width, m	$WR = 1,3 * W$	0,44	0,52	0,60	0,66	0,71	0,78
Length (minimum), m	$LR = 4,2 * L$	4,9	5,5	6,0	6,3	6,7	6,9
Race with sloping sides							
Width at bottom inside clear, m	$WR_b = 0,85 * W$	0,30	0,35	0,40	0,43	0,47	0,51
Width at 80 cm height inside clear, m	$WR = 1,3 * W$	0,44	0,52	0,60	0,66	0,71	0,78
Length (minimum), m	$LR = 4,2 * L$	4,9	5,5	6,0	6,3	6,7	6,9
Race fence							
Height (minimum), m	$HR = 1,15 * H$	1,25	1,36	1,46	1,53	1,59	1,63
Corral fence							
Height, m	$HC = 1,25 * H$	1,36	1,49	1,59	1,66	1,73	1,78
Loading chute							
Width, m	$WL = 1,4 * W$	0,48	0,56	0,64	0,71	0,77	0,84
Length (minimum), m		3,7	3,7	3,7	3,7	3,7	3,7
Rise (maximum), m/m		0,25	0,25	0,25	0,25	0,25	0,25

^a including cow-calf operations
^b worked immediately

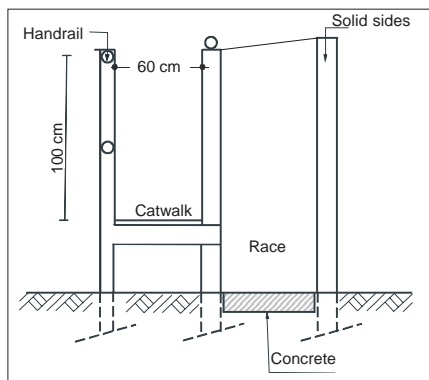

Figure 10-9: Cross-section of a catwalk with handrails.

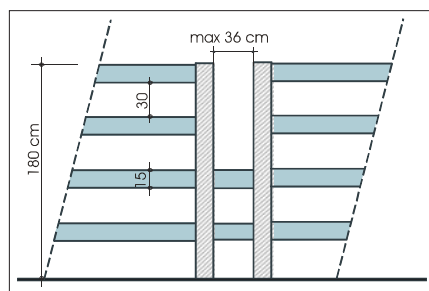

Figure 10-10: A personnel passage of a wooden yard fence.

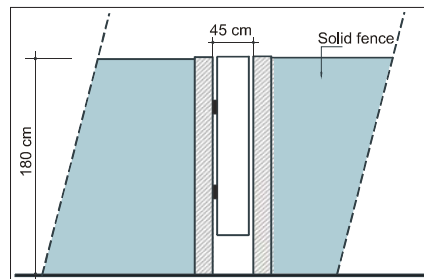

Figure 10-11: A personnel gate in a solid yard fence

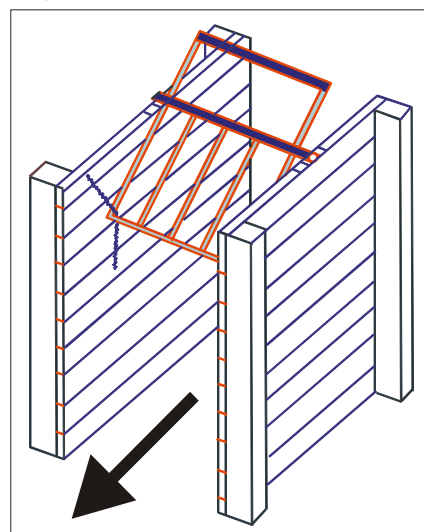

Figure 10-12: One type of a one-way gate (BORG, 1994).

handler to see over a high, solid fence, follow the cattle and manoeuvre animals while avoiding direct animal contact. The catwalk should be minimum 60 cm wide, or wide enough to provide a comfortable surface. The catwalk height should be 90 – 110 cm below the top of the fence or at belt buckle height, if one stands on the catwalk. With any less, there is a danger of toppling into the pen or race. Access to the catwalk should be provided by steps. Catwalks and walkways that are more than 60 cm off the ground should have handrails for worker safety (Figure 10-9).

- **Optional footholes/toe slots or escape boards/rails** along solid sides inside pens at a 60 cm height will make toe ledges, if one has to make a quick exit from the pen. High solid fences (over 180 cm high) should have grab rail to facilitate the escape.
- **Personnel passages**, 36 cm wide, well placed in yard fences for hasty retreat. The two plank pieces in Figure 10-10 in the gap are intended to keep calves inside the fold, but the planks can be designed to be removable.
- **Personnel gates**, 45 cm wide, spring loaded, no latches, open inward toward the cattle. Personnel escape gates are especially important in confined areas with solid fences such as the crowding pen where the handler may be deep in the animal's flight zone (Figure 10-11).
- **One-way gates**, to prevent cattle backing in the race (Figure 10-12) are a safer alternative to pipes placed behind animals in the race. If backstops are not installed and pipes must be used, be sure the pipe is between the cattle and worker. If not, a worker can be caught between the pipe and the chute or fence if the animal backs up before the pipe is extended through the race. One-way gates should be adjusted to block an animal 15 – 20 cm below the top of the tail head. However, too many backstop gates may cause backing and stop cattle movement through the facility. Install the one-way gate at least two body lengths up the race beyond the crowding pen, or let the one-way gate at the entrance be either tied open or remote controlled so it can be open as the animals enter.

- **Special bull pen** with several personnel passages (*Figure 10-13*)
- **Hydraulically powered restraint equipment** often is safer than manually operated facilities, because protruding lever arms are eliminated. In addition, a well-designed hydraulic crush takes less effort to use, is faster and sturdier than a manually operated crush. However, the pressure relief valve must correctly be set. Extreme pressure can cause severe injuries to both people and animals.
- **Latching devices** and protruding lever arms cause many injuries and are commonly described as “head-knockers” and “jaw-breakers”. To decrease the accidents, it is important to keep the latching devices well maintained and to avoid lever arms that protrude too long.
- Veterinarians performing rectal palpation might be injured, if a cow lies down and jams veterinarians arm. Use restraining methods that help circumvent this problem, e.g. types of **head**

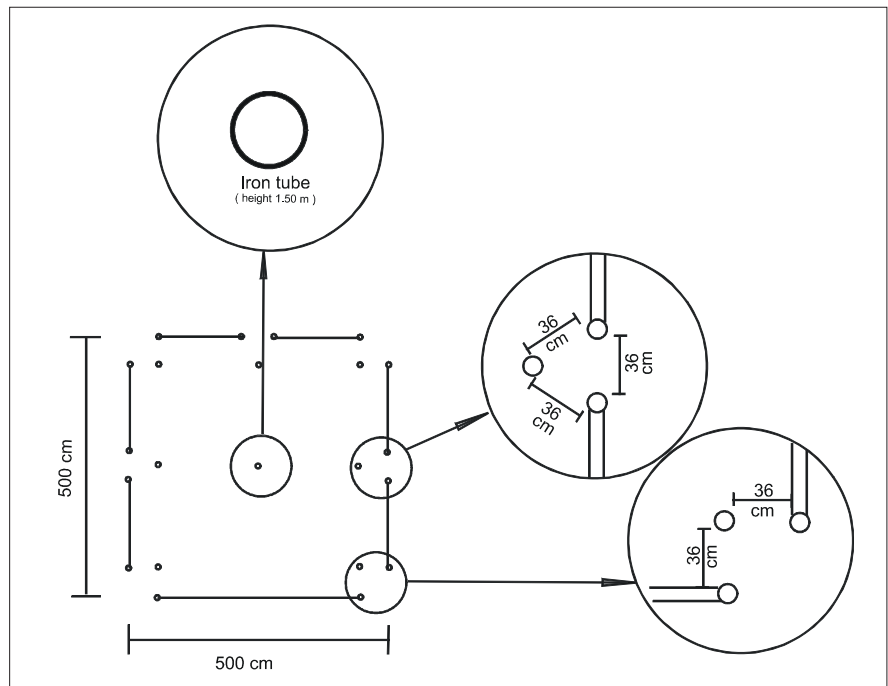

Figure 10-13: Bull pen with personnel passages and a central column.

gates that reduce the risk of animal choking and going down.

- Accidents occur when treating animals, which are caught around their hips by the head gates. To reduce the temptati-

on of working on an animal that is half out of the crush, install a **sorting gate in front of the crush** and a separate holding pen. Then the animal is easily moved back through the crush for reworking.

References

- ADAS, 1985: Beef Cattle Housing. Technical Booklet 2512. MAFF Publications, Lion House, Alnwick, Northumberland, UK.
- ANDERSSON, M., 1995: Ammonia volatilisation from cow and pig manure. Swedish University of Agricultural Science, Department of Agricultural Biosystems and Technology. Report 98. Lund.
- APPLE, K., HUHKE, R. L. and HARP, S., no date. Modern Corral Design. Oklahoma State University. Stillwater.
- BARNES, M. and MANDER, C., 1986: Farm Building Construction. Publ. Farming Press Limited, Ipswich, Suffolk, UK. ISBN 0-85236-159-9.
- BARTUSSEK, H., TRITTHART, M., WÜRZL, H. and ZORTEA, W., 1995: Rinderstallbau, Leopold Stocker Verlag, Graz, ISBN 3-7020-0722-9.
- BÂTIMENTS, V., Allaitantes, 1988: Une coproduction des Chambres d'Agriculture et de l'Institut de l'Élevage - Réseau des Conseillers Bâtiment de l'Ouest.
- BEAUCHAMP, R. O., BUS, J. S., POPP, J. A., BOREIKO, C. A. and ANDJELKOVICH, D. A., 1984: A critical review of the literature on hydrogen sulphide toxicity. *CRC Crit. Rev. Toxicol.* 13:25-97
- BICKERT, W. G., HOLMES, B., JANNI, K., KAMMEL, D., STOWELL, R. and ZULOVICH, J., 2000: Dairy freestall – housing and equipment. MWPS-7. Midwest Plan Service, Ames Iowa
- BORG, R., 1993: Corrals for handling beef cattle. Alberta Agriculture, Food and Rural Development. Edmonton.
- CHOINIÈRE, Y. and MUNROE, J.A., 1990: Natural ventilation for warm housing. Canada Plan Service Leaflet M-9760.
- CHOINIÈRE, Y., MUNROE, J. A. and SUCHORSKI-TREMBLAY, A., 1990: Sizing openings for naturally ventilated barns. Canada Plan Service Leaflet M-9765.
- CIGR, 1984: Report of Working Group on Climatisation of Animal Houses.
- CIGR, 1992: 2nd Report of Working Group on Climatisation of Animal Houses, 1989, 2nd Edition.
- CIGR 1994: The Design of Dairy Cow Housing. Report of CIGR Section 2 Working Group No.14: Cattle Housing. Publ. ADAS Bridgets Dairy Research Centre Farm Buildings Research Team.
- DE BELIE, N., LENEHAN, J. J., BRAAM, C. R., SVENNERSTEDT, B., RICHARDSON, M. and SONCK, B., 2000: Durability of building materials and components in the agricultural environment, Part III: Concrete structures. *J. agric. Engng Res.* (2000) 76,3-16.
- DECISION 1997: Decision 97/182/EC of the Commission of 24th February 1997 modifying the Directive 91/629/EEC establishing the Minimal Norms related to the Protection of Veal Calves of Agric. Biosystems and Technology. Report 103. Dissertation. Lund.
- MIDWEST PLAN SERVICE, 1995: Beef Housing and Equipment Handbook, MWPS 6, Forth edition.
- MIDWEST PLAN SERVICE, 1997: Dairy Freestall Housing and Equipment, MWPS 7, Sixth Edition.
- NILSSON, C. 1992: Walking and lying surfaces in livestock houses. 'Farm Animals and the Environment'. p. 93-110. Editors: C. Phillips and D. Piggins, CAB, International, UK. ISBN 0-85198 -7885.
- NOSAL, D. and STEINER, T., 1987: Flüssigmist-systeme: Funktion und Schadgaswerte. Eidg. Forschungsanstalt für Betriebswirtschaft und Landtechnik, Schrift Nr. 29. FAT Tänikon.
- PEARSON, C.C. and OWEN J.E., 1994: The Resistance of Air Flow of Farm Building Ventilation Components. *Journal of Agricultural Engineering Reserach*, 57, 53 - 65.
- PERSON, H. L. and DOSS, H. J., 1989: Hazardous gases in manure tanks in livestock operations. *Agricultural Engineering Information Series* 573. Michigan State University. East Lansing.
- RICHTER, T., 2002: Skid proofing of concrete stable floors. Proc. of 5th International Symposium on Concrete for a Sustainable Agriculture, Ghent, Belgium. p. 61-68. Editors: N. De Belie and B. Sonck. Ghent University and Agriculture Research Centre, Ghent, Belgium.
- RUIS-HEUTINCK, L.F.M., SMITS, M.C.J., SMITS, A.C., KANT, P.P.H., and HEERES-VAN DER TOL, J.J., 1999: Vloertypen en oppervlakte bij vleestieren. *Praktijkonderzoek Rundvee, Schapen en Paarden (PR)*. Publi. 140, December 1999.
- SCHNITZER, U., 1971: Abliegen, Liegestellungen und Aufstehen beim Rind im Hinblick auf die Entwicklung von Stalleinrichtungen für Milchvieh, KTBL-Bauschriften, Heft 10.
- STEFANOWSKA, J., SMITS, M. C. J., and BRAAM, C. R., 1998: Impact of floor surface on behaviour, locomotion and foot lesions in cattle. Report 98-09. 68 p. IMAG-DLO, Wageningen, The Netherlands. ISBN 90-5406-171.
- SWIERSTRA, D., STEFANOWSKA, J. and GROOT KOERKAMP, P. W. G. 2002: Prefabricated concrete grooved floors in cow houses: ammonia emission and walkability. Proc. of 5th International Symposium on Concrete for a Sustainable Agriculture, Ghent, Belgium. p. 309-316. Editors: N. De Belie and B. Sonck. Ghent University and Agriculture Research Centre, Ghent, Belgium.
- VALLET, A. and HOUDOY, D., 1985: Le logement des veaux nouveau-nés en élevage allaitant in *Bulletin technique vétérinaire*.
- VAN CAENEGEM, L. and SCHMIDLIN, A., 1998: Comparaison entre filets brise-vent et bardages à claire-voie. *Rapports FAT* nr. 526
- EU COMMISSION, 2001: The welfare of cattle kept for beef production. Health & Consumer Protection Directorate-General (Scientific Committee on Animal Health and Animal Welfare). SANCO.C.2/AAH/R22/2000.
- FLYNN, A. V. and KAVANAGH, A. J., 1989: A sloped floor system for the intensive housing of beef cattle. Proc. of 11th CIGR International Congress, Dublin. Editors: V.A. Dodd and P. Grace, Publ. Balkema, Rotterdam. ISBN -90 6191 9800
- GRANDIN, T., 1989: Behavioral Principles of Livestock Handling. *Professional Animal Scientist*, December 1989, pp 1 – 11, <http://www.grandin.com/references/new.corral.html>
- GRANDIN, T., 1994: Solving livestock handling problems. *Veterinary Medicine*, October 1994, pp 989 - 998
- GRANDIN, T., 1998: Cattle Handling Systems. Practical tips on why some handling systems work better than others. *Beef*, Sept 1998, pp. 50-52.
- GRANDIN, T., 1999a: Understanding Flight Zone and Point of Balance.
- GRANDIN, T., 1999b: Sample Designs.
- GRANDIN, T., 1999c: Safe handling of large animals (cattle and horses). *Occupational medicine: State of the art reviews*, vol. 14, No. 2. Hanley & Belfus Inc. Philadelphia
- GRANDIN, T., 1999: Loading chute and Catwalk Cross Section. <http://grandin.com/design/blueprint/ramp2.html>
- HARRIGAN, T. M. and BICKERT, W. G., 1986: Moisture related deterioration in Michigan freestall barns: a survey. Proc. of the Dairy Free Stall Housing Symposium, Northeast Regional Agricultural Engineering Service.
- HILTY, R., CAVELTY, C. and GUYOT, P. Y., 1999: Bauen in der Landwirtschaft, LMZ, Zollikofen.
- HOUDOY, D., CAPDEVILLE, J., CARROTTE, J. G., FOSTIER, B., TILLIE, M. and VALLET, A., 1989: Le logement des veaux d'élevage, Institut Technique de l'Élevage Bovin (ITEB).
- HOUDOY, D., 1991: Etables pour vaches allaitantes in *Techniques agricoles*, Institut Technique de l'Élevage Bovin (ITEB).
- HUBERT, D. J., HUHKE, R. L. and HARP, S. L., 1999: Cattle handling safety in working facilities. <http://www.okstate.edu/ag/agedcm4h/pearl/bioagen/bioagen/f1738.htm>
- INSTITUT DE L'ELEVAGE & MUTUALITÉ SOCIALE AGRICOLE, 1993.: Comment construire une installation de contention des bovins. Guide pratique. Paris.
- MALECKI, J. S., GORSKI, C., TUPAJ, M., LATORYSZCZAK, 1993: Effect of gravity ventilation facilities control on the microclimate condition in home stockfarm buildings. Proc. of the Fourth International Livestock Environment Symposium, Coventry, ASAE, St. Joseph, MI
- MÅRTENSSON, L., 1995: Concentration of dust, endotoxin and organic acids in confined animal buildings. *Swed. Univ. of Agric. Science, Dep.*

