

BIOLOGICAL NITROGEN FIXATION OF DIFFERENT LEGUME SPECIES UNDER WATER STRESS

BIOfix - Project

Case study in Austria

Component B

Field trial

Final report

Project leader: Univ. Prof. Dr. Bernhard Freyer
Project coordinator: Dr. Gabriele Pietsch
Project workers: Ao. Univ. Prof. Dr. Jürgen K. Friedel, DI Walter Starz,
Ao. Univ. Prof. Dr. Silvia Kikuta, Ao. Univ. Prof. Dr. Willibald Loiskandl,
DI Alexandra Strauss-Sieberth

Adress: **University of Natural Resources and Applied Life Sciences,
Vienna**
Department for Sustainable Agricultural Systems
Division of Organic Farming (IfÖL)
Gregor Mendel Strasse 33
1180 Vienna
Fax: 0043-1-47654-3764 Tel.: 0043-1-47654-3750
E-Mail: bernhard.freyer@boku.ac.at / gabriele.pietsch@boku.ac.at

Table of contents

1	Research question and aims of the project	6
2	Methods	6
2.1	Site description	6
2.2	Experimental set-up.....	6
2.1.1	Treatment variants.....	6
2.1.2	Variety description	7
2.1.3	Experimental design	8
2.3	Time course of the project work.....	9
2.4	Analytical methods.....	9
2.4.1	Soil water regime and water conductivity	9
2.4.2	Soil texture and bulk density.....	11
2.4.3	Inorganic soil nitrogen.....	11
2.4.4	Water use efficiency (WUE) of alfalfa	11
2.4.5	Total water potential (Ψ_t) of alfalfa plants and pressure-volume- curves.....	13
2.4.6	LAI – Leaf Area Index and growth height of the alfalfa plants	15
2.4.7	Yield parameters and nitrogen content of the plants	16
2.4.8	Estimation of nitrogen fixation (BNF) of alfalfa	16
3	Results and discussion	17
3.1	Weather during the experiment	17
3.2	Plant development	18
3.3	Soil water supply and water availability	21
3.4	Above and below ground biomass yield	22
3.5	Nitrogen fixation and yield	25
3.6	Evapotranspiration.....	29
3.7	Water use efficiency	31
3.8	Total water potential (Ψ_t) and results from pressure-volume-curves.....	35
3.9.	Comparison of varieties.....	42
4	Conclusion	44
5	References	45
6	Annex.....	48

List of figures

Figure 1: Plan of the field trial and one of the field plots	8
Figure 2: Schematic drawing of the continuous measuring device in field plot 10	10
Figure 3: Continuous measuring device in field plot 10.....	11
Figure 4: Schematic drawing of a pressure chamber apparatus.....	14
Figure 5: Schematic drawing of a pressure-volume-curve in typ II transformation.	15
Figure 6: Weather at the site “Raasdorf” from January to December 2004	17
Figure 7: Weather at the site “Raasdorf” from January to December 2005	18
Figure 8: Pea and bean weevil.....	19
Figure 9: Colour variation of alfalfa blossoms	19
Figure 10: Leaf Area Index (LAI) of alfalfa variants no 1-4 at harvests 1 and 2.....	20
Figure 11: Plant height during the first and the second growth of alfalfa variants no 1-4.....	20
Figure 12: Soil water supply within 160 cm soil depth during the vegetation period 2005.....	21
Figure 13: Total plant biomass yield of alfalfa variants no 1-4 at harvest 1	22
Figure 14: Total plant biomass yield of alfalfa variants no 1-4 at harvest 2	23
Figure 15: Alfalfa plants at harvest.....	25
Figure 16: Nitrogen yield of the total plant biomass of alfalfa variants no 1-4 at harvest 1	26
Figure 17: Nitrogen yield of the total plant biomass alfalfa variants no 1-4 at harvest 2	26
Figure 18: Nitrogen fixation (N_{fix}) and nitrogen derived from the atmosphere (N_{dfa}) of alfalfa variants no 1-4 at harvest 1.....	27
Figure 19: Nitrogen fixation (N_{fix}) and nitrogen derived from the atmosphere (N_{dfa}) of alfalfa variants no 1-4 at harvest 2.....	27
Figure 20: Inorganic soil nitrogen (NO_3 -N) of alfalfa variants no 1-4 at harvest 1	28
Figure 21: Evapotranspiration of alfalfa variants no 1-4 from April to August 2005	29
Figure 22: Precipitation and Evapotranspiration per day of alfalfa variants no 1-4 during the vegetation period 2005.....	31
Figure 23: Evapotranspiration coefficient of alfalfa variants no 1-4 from April to August 2005	32
Figure 24: Shoot DM yield and Evapotranspiration of alfalfa variants no 1-4 during the vegetation period 04-08/2005	33
Figure 25: $\delta^{13}C$ -value of alfalfa variants no 1-4 at harvests 1 and 2.....	35
Figure 26: Measuring water potential in the field.....	37
Figure 27: Saturation deficit and potential Evapotranspiration.....	38
Figure 28: Osmotic Potential at the turgor loss point and total water potential at noon of alfalfa variants no 1-4 at harvests 1 and 2	39
Figure 29: Turgor potential and Water potential of alfalfa variants no 1-4 at harvest 1.....	40
Figure 30: Turgor potential and Water potential of alfalfa variants no 1-4 at harvest 2.....	41
Figure 31: Turgor potential and Relative water content of alfalfa variants no 1-4 at harvest 2	42
Figure 32: Texture of the soil profile at measuring tube R7 (plot 1) and R19 (plot 12), representing a mighty and shallow Loess layer, resp.	52
Figure 33: Altitude model of the experimental site	53
Figure 34: Saturation deficit and air humidity at the site “Raasdorf” from 1.4.-31.8.2005	53
Figure 35: Saturation deficit and temperature at the site “Raasdorf” from 1.4.-31.8.2005	54

List of tables

Table 1: Variants, reference crops and germination rates	6
Table 2: Origin of varieties	7
Table 3: Variety description – specification of parameters	7
Table 4: Properties assessed on the field plots.....	9
Table 5: Sequence of tasks in the sub-project	9
Table 6: Variance components of soil water supply, 17 March 2005	21
Table 7: Root and shoot dry matter yield of alfalfa in the 1. and 2. year of utilization at different sites.....	24
Table 8: DM yield and N yield ratio (proportion of above to below ground biomass or nitrogen yield) of alfalfa variants at the Raasdorf site in the year 2005	24
Table 9: Nitrogen fixation (N_{fix}), Nitrogen derived from atmosphere (N_{dfa}) and inorganic soil nitrogen (NO_3-N) of alfalfa (mean value) at harvest 1 at the site Raasdorf.....	28
Table 10: Evapotranspiration (ET in mm) and Evapotranspiration coefficient (ETC in $L\ kg^{-1}$) of alfalfa variants no 1-4 during two time intervals	30
Table 11: Evapotranspiration (mm) of alfalfa variants no 1-4 at the site Raasdorf	30
Table 12: Evapotranspiration coefficient ($L\ kg^{-1}$) of alfalfa (mean of variants no 1-4) at the site Raasdorf.....	32
Table 13: Water use efficiency (WUE_p , calculated by water balance), Isotope discrimination, Evapotranspiration (ET), Harvest index (HI) and shoot yield of alfalfa variants no 1-4 at harvests 1 and 2 in 2005	34
Table 14: Total water potential at noon of alfalfa variants no 1-4.....	36
Table 15: Climatic parameters, saturation deficit and soil water potential at the continuous measuring device in field plot 10 at harvests 1 and 2	37
Table 16: Osmotic potential at full saturation of alfalfa variants no 1-4.....	39
Table 17: Specific plant parameters of alfalfa variants no 1-4 at harvests 1 and 2.....	48
Table 18: Dry matter yield of shoot, stubbles and roots of alfalfa variants no 1-4 at harvests 1 and 2.....	49
Table 19: Nitrogen content and Nitrogen yield of shoot, stubbles, roots, leaves and stem of alfalfa variants no 1-4 at harvests 1 and 2	50
Table 20: Nitrogen fixation and Nitrogen derived from the atmosphere of alfalfa variants no 1-4 at harvests 1 and 2	51

Abbreviations

BNF	biological nitrogen fixation	LAI	leaf area index
RC	reference crop	DM	dry matter
N	nitrogen	WUE	water use efficiency
ET	evapotranspiration	ETC	evapotranspiration coefficient
HI	harvest index	pV	pressure volume
N_{fix}	nitrogen fixation	N_{dfa}	nitrogen derived from atmosphere
Ψ_t	total water potential	Ψ_o	osmotic potential
sat	full saturation	tlp	turgor loss point
RWC	relative water content		

Abstract

The main source of nitrogen in organic farming is biological nitrogen fixation, the result of a symbiosis between legumes and nodulating bacteria. Alfalfa (*Medicago sativa* L.) is the most efficient legume under the semiarid conditions in Eastern Austria. Farmers inquired information about the best site-adapted alfalfa variety, but knowledge about water use and productivity of different alfalfa varieties in organic farming is sparse. During the vegetation period 2005 four alfalfa varieties were investigated with respect to biomass production (above- and below-ground), biological nitrogen fixation, water use and water potential. The aim of this study was to find first practical criteria for farmers to choose alfalfa varieties for green manure, adapted to the dry region in the Marchfeld region.

The weather in 2005 was characterised by sufficient soil water availability in March but moderately dry conditions from March to July by a sum of precipitation during the vegetation period of 61 mm below the long-term average. The shoot biomass production ranged from 4.2 to 4.8 t DM ha⁻¹ per year, the below-ground biomass yield varied from 9.8 to 12.0 t DM ha⁻¹ at the second harvest. Biological nitrogen fixation of alfalfa amounted to 280 – 380 kg N ha⁻¹. From April to August 2005, 302 – 374 mm of water was used by the crops, the water use efficiency was around 660 – 810 L (kg DM)⁻¹. Generally, the tested alfalfa varieties did not differ in their performance during the vegetation period 2005 when only little drought occurred. Less negative water potentials measured at noon, a more positive turgor potential and a greater water use efficiency of the variety *Vlasta* compared to *Tango* indicated a better drought adaptation of *Vlasta*. *Tango* seemed to be not very efficient in its use of water resources because of the higher evapotranspiration rate and the lower WUE. The varieties *Sitel* und *Verko* were able to maintain positive turgor potentials which could be a hint to osmotic adjustment under water stress. Additional research is needed, for example comparison of the varieties under conditions of more severe drought, e.g. by induced water stress in the greenhouse.

Key words: alfalfa, nitrogen fixation, water stress, water potential, evapotranspiration.

1 Research question and aims of the project

The main source of nitrogen in organic farming is biological nitrogen fixation (BNF). BNF is the result of a symbiosis between legumes (family *Fabaceae*) and nodulating bacteria (*rhizobia*). Therefore, legumes are an integral part of crop rotations in organic farming. The climate in Eastern Austria is stamped by dry summers. The resulting low water supply can considerably impair the BNF rate of legumes and their constructive effect on soil fertility (Peoples et al. 1992, Stülpnagel 1982). In a preceding study (Pietsch 2004), alfalfa (*Medicago sativa* L.) proved to be the most efficient legume under dry conditions. Therefore, in this study four alfalfa varieties were chosen to compare their performance with respect to biomass yield, BNF, and water use efficiency. The best site-adapted variety was to be determined.

2 Methods

2.1 Site description

The trial is located on the organically managed fields of the research station „Gross-Enzersdorf“ of the University of Natural Resources and Applied Life Sciences, Vienna, in Raasdorf. Soils are Calcaric Phaeozems from Loess with a silty loam texture, organic carbon contents of 2.2 % and a $\text{pH}_{\text{CaCl}_2}$ value of 7.6 in the topsoil. The soils are described in detail in Freyer et al. (2000). The level of the soil surface was assessed by geometrically correct levelling and expressed in an altitude model. Maximum differences in altitude within the trial were 20 cm (Figure 34).

2.2 Experimental set-up

2.2.1 Treatment variants

Treatment variants differ with respect to the alfalfa varieties (Table 1). To estimate BNF, a part of each field plot was cropped with a grass mixture as reference crop. The seeding density was 25 kg ha^{-1} in all cases.

Table 1: Variants, reference crops and germination rates

Variant	Alfalfa varieties, grass species ¹	TSW (g)	Germination rate (%)
1	Vlasta	2.4	83.5
2	Tango	2.2	82.5
3	Sitel	2.3	88.5
4	Verko	-	-
RC	False Oat	2.9	24.0
	Red Fescue	1.1	72.5
	Cock's Foot	1.1	62.5
	Perennial Ryegrass	2.0	92.5

TSW: Thousand seed weight, RC: Reference crop

1: The grass mixture consists of 25% of each of the mentioned species.

2.1.2 Variety description

The tested varieties have different countries of origin (see Table 2) and are characterized by the following scale (see Table 3).

Table 2: Origin of varieties

Variety	Vlasta	Tango	Sitel	Verko
Variant No.	1	2	3	4
Country of Origin	Czech Republic	France	Netherlands	Hungary
Maintainer	Agrogen s.r.o. Zahradni I a 664 41 Troubsko	Serasem 10-12 rue Roger Lecerf 59840 Premesques	Barenbrug Holland BV, Stationsstraat 40 6678 AC Oosterhout	Fleischmann Rudolf Landwirtschaftliches Forschungsinstitut Fleischmannstr. 4 H-3356 Kompolt

Vlasta is recommended for perennial utilization at dry and humid sites. This variety has a high resistance to lodging and reached high dry matter and protein yields (according to Saatbau Linz 2005, http://www.saatbaulinz.at/default.asp?site=http://www.saatbaulinz.at/sor_produkliste.asp, 2006).

Tango is a very high (seed) yielding, semi-dormant variety with excellent multileaf expression for late summer growth. Tango is best suited for alfalfa management programs desiring 4-8 cuttings, possesses high resistance to 8 major alfalfa pests (Fusarium wilt, Phytophthora root rot, Anthracnose, Verticillium wilt, pea aphid and spotted alfalfa aphid). Tango is a synthetic variety with 30 parent plants. Approximate germplasm source contributions are: *M. falcata* (1%), Ladak (12%), *M. varia* (5%), Turkistan (22%), Flemish (11%), Chilean (11%), Peruvian (1%), Indian (12%), African (16%) and unknown (9%). The flower colour is 100% purple with a trace of variegated, yellow, cream and white (<http://www.naaic.org/varietyaps/Tango.html>; <http://www.eurekaseeds.com/alfalfa-varieties.html>).

Table 3: Variety description – specification of parameters

Parameter	Vlasta	Tango	Sitel	Verko
Flowering date	6	-	4	4
Plant height	5	-	5	5
Regrowth score	2	-	4	5
Winter survival	3	-	3	5
Resistance to lodging	4	-	3	4
Resistance to Weed infestation	4	-	2	
Resistance to Verticillium	-	6	2	-
Shoot DM yield	6	6	6	5
Crude protein	6		6	6

References: <http://www13.ages.at/servlet/sls/Tornado/web/ages/content/8278B47A5305607EC1256F7300>, 2006; http://www.bundessortenamt.de/isapi/drvisapi.dll?MIval=bsl_int_Sorte&MItab=wbpages&p_jahr=2004&p_sortimenf=1&p_knr=137&p_kbst=LUZ; 2006).

Sitel is the leading variety in Europe. Sitel is a Flemish type, adapted to cold winter conditions (continental climates), fine stemmed, with an excellent resistance to Verticillium and high levels of protein.

Verko: is a fine stemmed, high yielding variety, with multileaf expression and a high resistance to Verticillium (http://www.camena-samen.de/liste_2005_oP.pdf, 2006).

2.1.3 Experimental design

The field plots were laid out in a Latin Square design in four replicates (Figure 1). All variants are present in each replicate (E-W direction) and in each column (N-S direction). Each plot was divided into a subplot of 37 m² of alfalfa and a second subplot of 30 m² of the reference crop. Within each alfalfa sub-plot, part of the area was designated for yield measurements and soil sampling, and part of the area for water content measuring with an FDR probe. In the sub-plots containing the reference crop, FDR probes were installed only in the plots of legume variant 4 (variety Verko). Plot No. 10 (variant 4) was additionally equipped with an instrumentation for continuous soil water assessment.

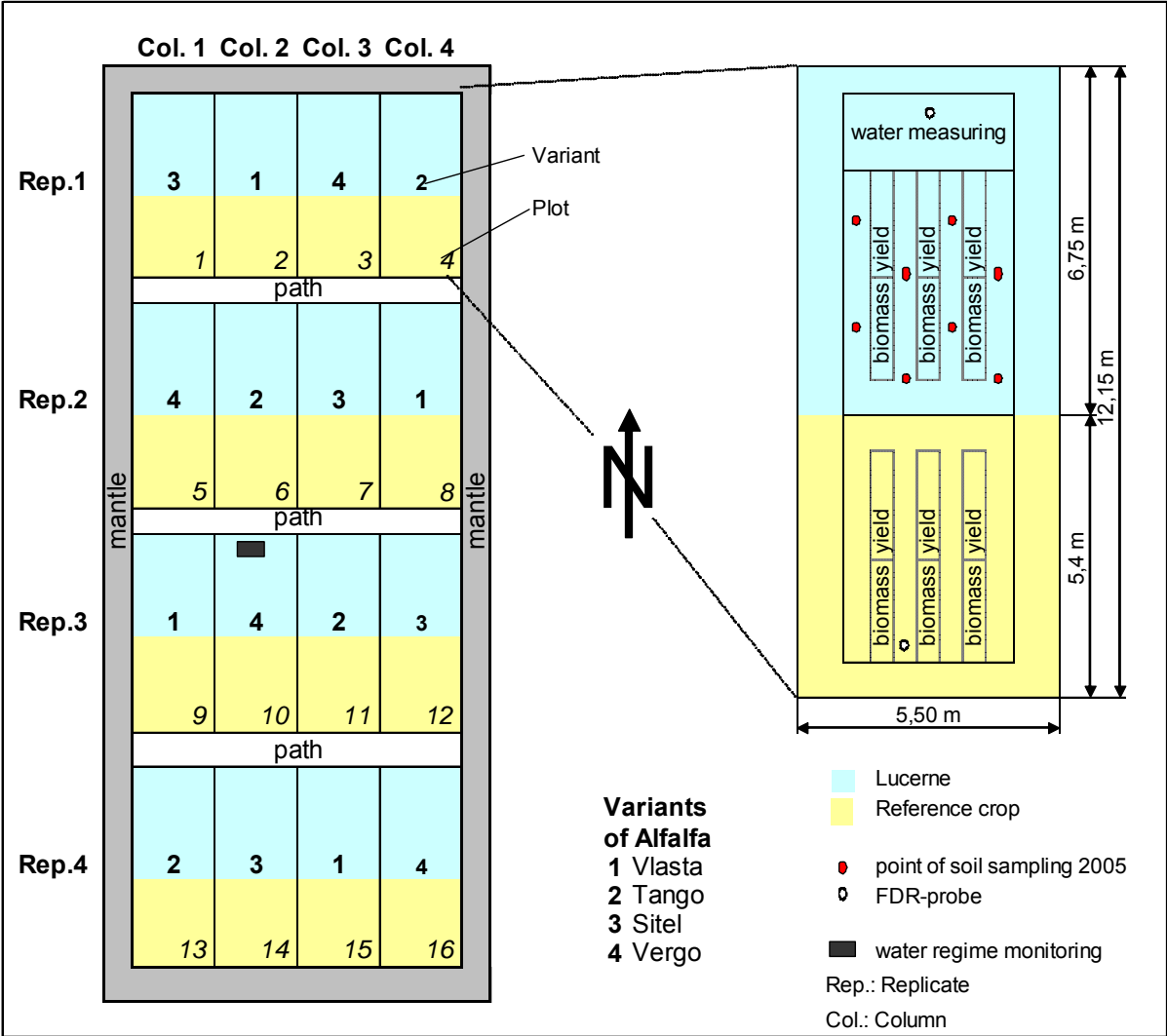

Figure 1: Plan of the field trial and one of the field plots

The properties listed in Table 4 were assessed on the field plots. Green manure use that is common on stockless farms was chosen for all variants.

Table 4: Properties assessed on the field plots

Parameter	Date
DM yield shoots, stubbles, roots	1., 2. and 3. time of alfalfa use
Biomass distribution above- / below-ground	1., 2. and 3. time of alfalfa use
N content (%) shoots, stubbles, roots	1., 2. and 3. time of alfalfa use
BNF and % N derived from the air (%N _{dfa})	1., 2. and 3. time of alfalfa use
Water use efficiency of productivity	1., 2. and 3. time of alfalfa use
Water use efficiency of photosynthesis (¹³ C method)	1., 2. and 3. time of alfalfa use
Stress resistance / Total water potential	1., 2. and 3. time of alfalfa use
Plant height, developmental stage	1., 2. and 3. time of alfalfa use
Leaf area index (LAI)	several times
Plant density (plants per m ²)	before and after winter
Occurrence of weeds and pests	before and after winter, all times of alfalfa use
Soil water content	weekly, except during frost
Soil texture	at the beginning of the trial (April 2004)
Inorganic nitrogen (N _{in})	1. time of alfalfa use

2.3 Time course of the project work

The tasks listed in Table 5 have been conducted since the beginning of the trial. The first main year of alfalfa use was 2005.

Table 5: Sequence of tasks in the sub-project

Task	Date
Sowing of winter rye	October 2003
Sowing of alfalfa and reference crop as underseed in winter rye	April 2004
Installation of instruments for measuring soil water content and tension	April 2004
Disturbed soil samples for texture analysis	April 2004
Undisturbed soil samples for analysis of water conductivity	May 2004
Yield of winter rye	July 2004
Application of ¹⁵ N fertiliser	May 2005
1. time of alfalfa use: yield (DM, N), N _{in}	June 2005
2. time of alfalfa use: yield (DM, N)	August 2005
Measurement of water content and water tension	continuously
Crop estimates	continuously

2.4 Analytical methods

2.4.1 Soil water regime and water conductivity

Soil water content was measured by a SENTEK Diviner2000 FDR system. A measuring tube was installed in the soil of all alfalfa sub-plots. Mobile probes that are brought in the tube measured the water contents every 10 cm down to a depth of 120 cm. In the sub-plots

containing the reference crop, FDR probes were installed only in the plots of legume variant 4 (variety Verko) because the reference crop consists of the same grass mixture in every variant. Soil water content was measured weekly, except during periods of frost.

Field plot No. 10 was equipped with a continuous measuring device consisting of three FDR-tube probes measuring to a depth of 160 cm, four watermarks (gypsum blocks) installed in 10 cm and 30 cm, and four tensiometers measuring water tension in 120 cm and 160 cm (Figure 2). By the combination of continuous measuring device and weekly assessment in all plots, information on both the spatial and temporal changes in water contents was available. Soil samples in cylinders of 200 cm³ were taken from a soil profile adjacent to the field trial in the West of field plot 9. On these undisturbed samples, the unsaturated water conductivity (k_s value) was assessed according to the method of increasing water table.

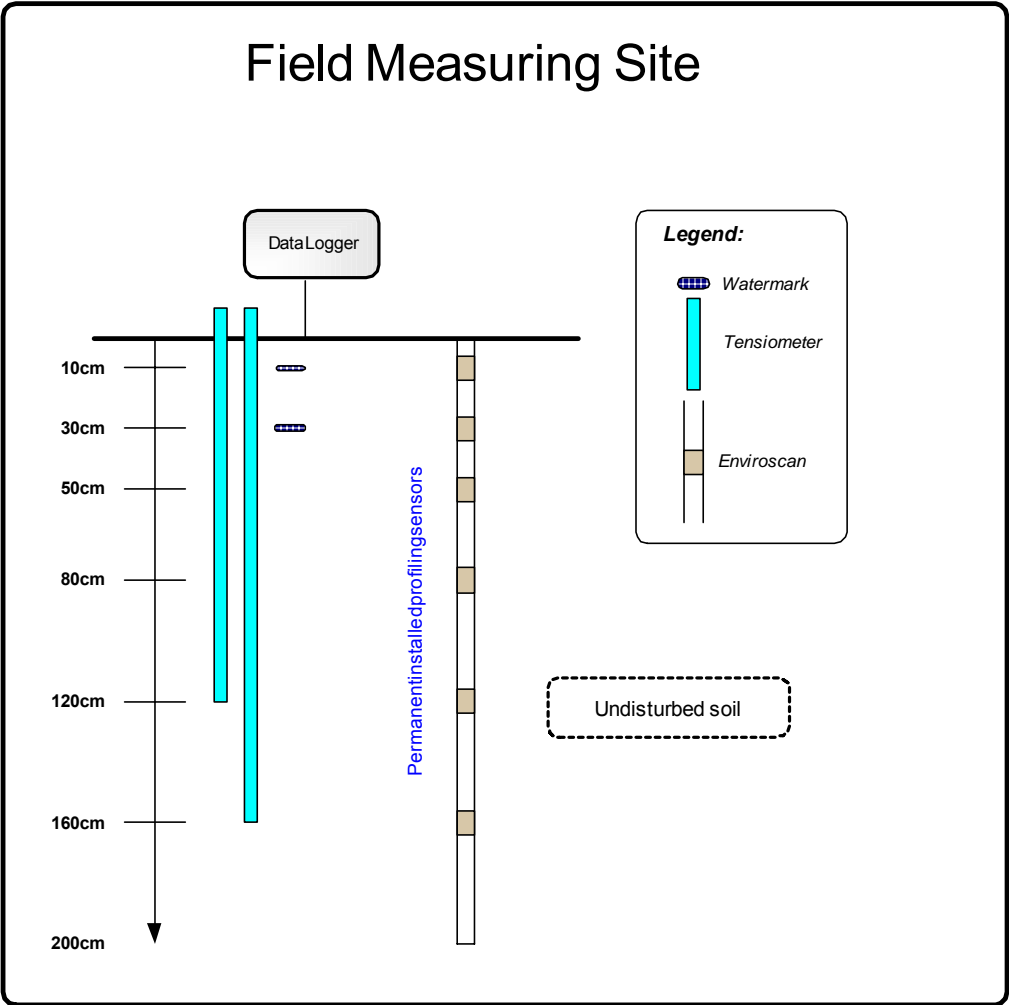

Figure 2: Schematic drawing of the continuous measuring device in field plot 10



Figure 3: Continuous measuring device in field plot 10

2.4.2 Soil texture and bulk density

During installation of the SENTEK tubes, soil samples were taken down to a depth of 150 cm to achieve information on the soil build up. On these samples, soil texture was determined by a combination of sieve and sedimentation analysis according to ÖNORM L 1061. Soil texture varied from silty loam in the topsoil to silty sand in the subsoil (Figure 33 in annex). Limited conclusions on the water permeability were possible. The simultaneously assessed gravimetric water content gives insight into the change of water content with soil depth. By assessing bulk density and solid density, these values can be converted into volumetric water contents and serve as a reference for the continuous measuring device. Bulk density was determined by determining the dry weight of undisturbed soil samples with defined volume (see Chap. 2.3.1).

2.4.3 Inorganic soil nitrogen

To assess soil inorganic N (N_{in}) contents soil samples were taken from 0-30 cm, 30-60 cm and 60-90 cm at the first time of alfalfa use in June 2005. N_{in} was extracted from the soil by $CaCl_2$ solution according to ÖNORM L 1091. Inorganic N in the solution was determined photometrically.

2.4.4 Water use efficiency (WUE) of alfalfa

Water use efficiency of productivity (WUE_P):

The WUE_P is an integral expression of the cumulative increase in dry matter and the water consumption over long periods, extending from weeks to entire growing seasons.

$$WUE_P = \text{Organic dry matter production} / \text{water consumption [g DM kg}^{-1} \text{ H}_2\text{O]}$$

Formula 1

The water requirement per unit of dry mass produced varies among species and varieties and is strongly dependent on the individual state of plant development, plant density, environmental conditions, and most importantly on the water supply and evaporation state. Understanding the WUE_P of crop plants, one can select species and varieties appropriate for the growing conditions in dry areas and thus adjust the amount of water used for irrigation.

Current water consumption and evapotranspiration indices were calculated from current evapotranspiration rates during the vegetation period (mid April – end of August 2005). Evapotranspiration of the crops was calculated according to the Penman Monteith method (Allen et al., 1998) and by using the climatic water balance (Ehlers and Goss 2003), as follows.

$$N + B = T + E + A + S \pm R$$

Formula 2

N = precipitation
T = transpiration
A = surface runoff
R = change in the water content of the soil profile (0-100 cm)

B = irrigation
E = evaporation
S = leaching

Precipitation and weather data were measured with a gauging station of the Institute for Crop Production and Plant Breeding in about 500 m distance. Irrigation levels are known. Changes in soil water content were determined from the water content of soil samples (taken on all test plots to a depth of 90 cm, low temporal resolution) and from soil FDR probes (one test compartment per variant, to a soil depth of 120 cm, high temporal resolution see Figure 2). Surface run off was ignored, since the test area is flat ($A = 0$; see also Figure 34). Growth periods when no leaching occurs ($S = 0$) were identified by measuring the potential gradient (using tensiometers, see Figure 2) at the bottom of the main root layer (at a depth of about 170 cm, bordering the gravel layer). In such periods, the following simplified equation was applied:

$$T + E = N + B - \Delta R$$

Formula 3

Water use efficiency of photosynthesis (WUE_{Ph}):

The water use efficiency of photosynthesis is a quantitative measure of the instantaneous gas exchange of the leaf. Dry matter production and water consumption can be expressed with reference to a single plant or to a plant stand; in the latter case, the production of organic dry matter is referred to the area of the stand, and the value for water consumption is the overall evapotranspiration. The WUE_{Ph} describes the ratio of photosynthesis and transpiration, i.e. the water use of photosynthesis (Larcher 1994) and is calculated as:

$$WUE_{Ph} = Ph / Tr [\mu\text{mol CO}_2 \text{ m}^{-2} \text{ s}^{-1} / \text{mmol H}_2\text{O m}^{-2} \text{ s}^{-1}]$$

Formula 4

Values of WUE_{Ph} fluctuate considerably throughout the day and the season. To assess WUE_{Ph} , the $\delta^{13}\text{C}$ isotope method was applied. The isotope ratio of ^{13}C and ^{12}C in plant dry matter is related to a standard and expressed in per mill ($\delta^{13}\text{C}\text{‰}$; an enrichment of ^{13}C is expressed by a more negative $\delta^{13}\text{C}\text{‰}$ value). The $\delta^{13}\text{C}$ values vary with crops (C_3 plants have lower $\delta^{13}\text{C}$ values than C_4 plants), weather conditions, light intensity, CO_2 uptake from the soil air, growth temperature, air pressure and, ozone concentration. Since WUE_{Ph} is negatively associated with $\delta^{13}\text{C}$ isotope values, differences in the water use efficiency of alfalfa varieties can be estimated by assessing the $^{13}\text{C}/^{12}\text{C}$ isotope ratio in above-ground plant biomass (Farquhar et al. 1989). The stable isotope ratio ($\delta^{13}\text{C}$) is expressed as the $^{13}\text{C}/^{12}\text{C}$ ratio (R_{sample}) relative to the PeeDee belemnite standard (R_{standard} : -8‰) (Craig 1957):

$$\delta^{13}\text{C-value [‰]} = (R_{\text{sample}}/R_{\text{standard}} - 1) \times 1000$$

Formula 5

The resulting $\delta^{13}\text{C}$ -value was used to estimate isotope discrimination (Δ) as described by Farquhar et al. (1989):

$$\Delta = (\delta^{13}\text{C}_{\text{air}} - \delta^{13}\text{C}_{\text{plant}})/(1 + \delta^{13}\text{C}_{\text{plant}})$$

Formula 6

Carbon isotopic composition values were determined on the plant samples with a mass spectrometer (ThermoQuest Finnigan DELTA^{plus}) in the laboratory of the University of Göttingen.

2.4.5 Total water potential (Ψ_t) of alfalfa plants and pressure-volume-curves

Total water potential (Ψ_t):

The water status in plant systems is estimated in terms of water potential, which is a measure of free energy available to do work. Water moves spontaneously from regions of higher (less negative) water potential to regions of lower (more negative) water potential. The whole plant may be considered to be a conduit of water between the humid soil and the dry air, and water will flow from points where it has more energy content to those with less energy content, that is, from the soil to the atmosphere. Total water potential (Ψ_t) is the central parameter of plant water relations and describes the energy state of water at a given point in the soil - plant - atmosphere continuum.

Total water potential of alfalfa plants was measured with the pressure chamber technique (Scholander et al. 1965) in 2005. The pressure chamber (Soilmoisture Equipment Corp.) is

an instrument very suitable for measurement of water potential especially in field work (see Figure 4).

Measuring principle:

A plant organ, for instance a leaf, or leaf strip, a twig or root is cleanly cut from the plant and immediately placed in the chamber head with the cut end protruding through a flexible rubber gasket which seals the chamber. Then compressed air is led slowly into the chamber, thus increasing the pressure inside gradually. Pressure is applied until water begins to return to the cut surface. This 'balance pressure' required to force water back to the cut end is equal in magnitude but opposite in sign to the tension in the xylem that existed in the intact plant material prior to excision. Since the osmotic potential of xylem sap is usually less than 0.02 MPa, the negative value of the balance pressure therefore equals the original water potential of the intact organ.

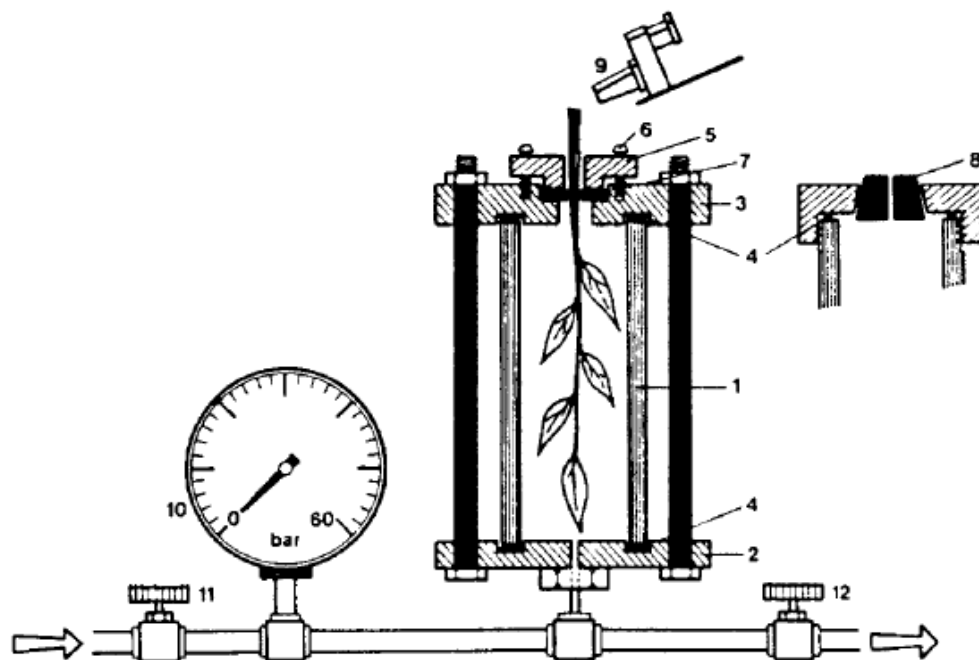

Figure 4: Schematic drawing of a pressure chamber apparatus.

1: cylinder, 2: lower cover, 3: upper cover, 4: O-rings, 5: insertion held with four screws (6) used to seal the stem by means of an O-ring (7), 8: rubber stopper, 9: binocular microscope, 10: pressure gauge, 11: inlet valve, 12: outlet valve (Slavik 1974).

Pressure-volume (pV)-curves:

Pressure-volume (pV) curves describe the relationship between total water potential (Ψ_t) and relative water content (R) of living organs. Linear relationships may be obtained by converting either potential or water content to its reciprocal. We can plot Ψ_t vs. $1/R$ (type I transformation) or $1/\Psi_t$ vs. R (type II transformation). Both of these transformations have certain advantages. A type I transformation allows analysis of the whole turgor range, a type II transformation is generally superior for estimating osmotic potentials at full saturation from

linear regression analysis (Kikuta 2003; Kikuta and Richter 1992). In the present study we used the typ II transformation (see Figure 5). Three significant water relations parameters can be derived from a pV curve: First, the potential at which the straight 'osmotic line' intercepts the vertical at $R^{-1} = 1$, the 'saturation line' gives the osmotic potential at full saturation ($\Psi_{o(sat)}$). Second, the point where the line curving down from a water potential of 0 meets the 'osmotic line' gives the osmotic potential at the turgor loss point ($\Psi_{o(tlp)}$). To the right of $\Psi_{o(tlp)}$, the cell or organ is flaccid. Third, the relative water content at the turgor loss point may be assessed by using algorithms (by graphical evaluation).

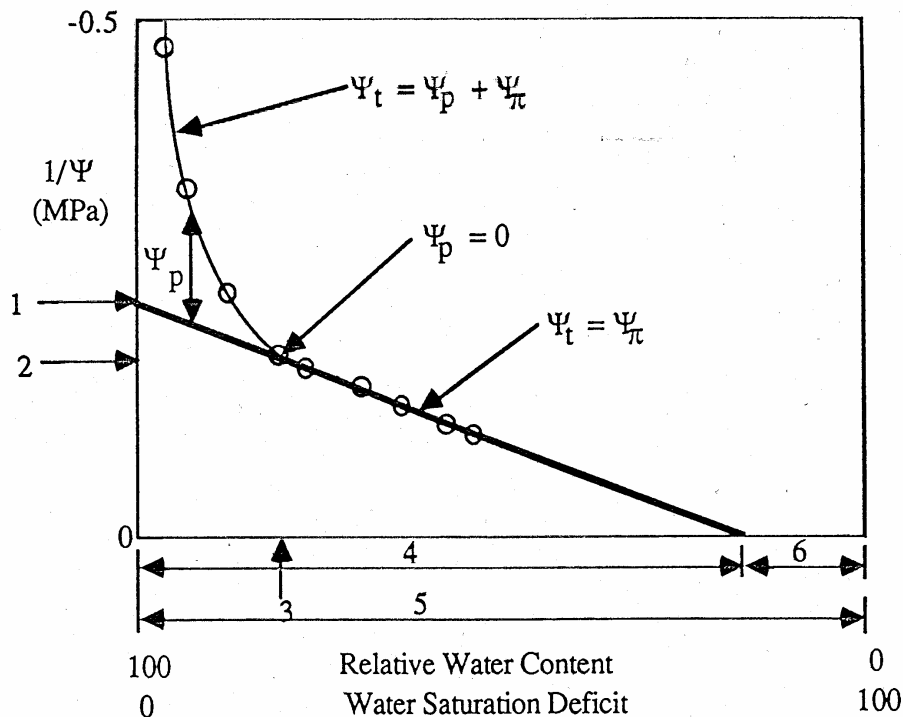

Figure 5: Schematic drawing of a pressure-volume-curve in typ II transformation.

Ψ_t : total water potential, Ψ_p : turgor potential, Ψ_π : osmotic potential. (1) Determination of the osmotic potential at full saturation by linear regression (2) Osmotic potential at turgor loss point (3) Relative water content at turgor loss point (4) Water content of symplast (6) Water content of apoplast.

2.4.6 LAI – Leaf Area Index and growth height of the alfalfa plants

Leaf area was determined with a portable leaf area meter (AM 100, ADC) and the leaf area index (LAI) calculated as m^2 leaf area / m^2 soil area. Measurements were done at several developmental stages of the alfalfa crop.

$$LAI = A_{Leaves} / A_{Soil}$$

Formula 7

2.4.7 Yield parameters and nitrogen content of the plants

The crops were harvested at two times during the vegetation period, as determined by the development of the alfalfa crop (beginning of flowering). The shoot weight of ^{15}N -labelled plant material was assessed by cutting (using scissors) crop growth within $2 \times 1 \text{ m}^2$. Total shoot dry matter (DM) was determined by drying an aliquot at 105°C until the weight remained constant. Part of the plant material was dried at 60°C for 48 h, ground up to fine powder, and analysed for N content and ^{15}N isotope ratios (using mass spectrometer ThermoQuest Finnigan DELTAplus) in the laboratory of the University of Göttingen.

Stubbles were sampled using a saw, roots using a root auger, 10 cm in diameter, in two layers (0 – 30 cm and 30 - 60 cm) in four replicates (two replicates within the rows, two replicates between the rows). The roots were subsequently separated from soil by a hydro pneumatic elutriation system (Gillison's Variety Fabrication Inc., USA) through a sieve with a mesh of $760 \mu\text{m}$. The harvested stubbles and roots were prepared and analysed in the same way as the shoot material.

2.4.8 Estimation of nitrogen fixation (BNF) of alfalfa

BNF is mainly estimated by either the natural ^{15}N abundance method or the ^{15}N dilution method.

The natural ^{15}N abundance method ($\delta^{15}\text{N}$ dilution method)

This method exploits the slight differences between the natural abundance of the stable isotopes ^{14}N and ^{15}N in plant-available soil N (approx. 0.3672 atom% ^{15}N) and in molecular N in the air (0.3663 atom% ^{15}N). BNF is then estimated by comparing the $^{15}\text{N}/^{14}\text{N}$ ratio in material from a non-nodulating plant (reference crop, reflecting the isotope ratio in the soil N pool) with the equivalent ratio in the legume. The most important precondition for this method to hold is that the $\delta^{15}\text{N}$ -value of the reference plant must be significantly (at least 5 ‰) different to the $\delta^{15}\text{N}$ -value of the air (Shearer and Kohl 1993).

The ^{15}N -isotope dilution method

The plant-available soil N pool will be enriched with ^{15}N by applying ^{15}N fertilizer, thereby artificially increasing the difference between the $^{15}\text{N}/^{14}\text{N}$ ratio of the air and that of the soil N pool. A legume and reference crop will be grown on the ^{15}N -labelled soil. The percentage of legume N content derived from the air (N_{dfa}) can be calculated using the isotopic differences between the two crops (McAuliffe et al. 1958):

$$N_{\text{dfa}} = [1 - (\text{atom } \% \text{ }^{15}\text{N} \text{ excess legume} / \text{atom } \% \text{ }^{15}\text{N} \text{ excess reference crop})] * 100\%$$

Formula 8

In preliminary work at the experimental site, it was found that the $\delta^{15}\text{N}$ -value of the plant-available N pool is below 5 ‰. BNF and % Ndfa will therefore be estimated using the ^{15}N

dilution method. The soil was labelled with ^{15}N at the beginning of the vegetation period 2005 (May), received $0.1 \text{ kg } ^{15}\text{N ha}^{-1}$ (N as $1 \text{ kg potassium nitrate ha}^{-1}$, $10 \text{ at\% } ^{15}\text{N}$).

The amount of N from BNF can be calculated as follows:

$$N_{\text{fix shoot}} [\text{kg ha}^{-1}] = N_{\text{dfa}} * \text{shoot N content} * \text{DM yield} [\text{kg ha}^{-1}]$$

Formula 9

N_{fix} = amount of N from BNF
 N_{dfa} = nitrogen derived from the atmosphere
 DM yield = dry matter yield of legume shoots

3 Results and discussion

3.1 Weather during the experiment

The temperature paralleled the annual mean values from January until December 2004 (Figure 6). Although the precipitation reached the long-term mean values, the distribution diverged considerably. Precipitation exceeded long-term mean values in spring and autumn, whereas the summer (July until September) was too dry. The water deficit in summer was compensated by irrigation ($2 \times 5 \text{ mm}$ in early September).

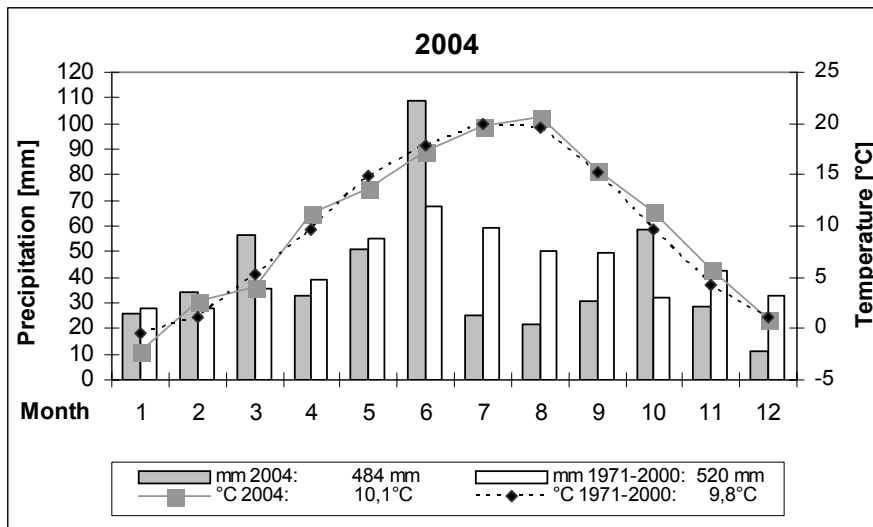

Figure 6: Weather at the site "Raasdorf" from January to December 2004

In 2005, the temperature also paralleled the annual mean values from January until December (Figure 7). The precipitation sum of the whole year 2005 decreased compared to the long-term values (413 mm in 2005; 520 mm 1971-2000). From July to August the precipitation exceeded the long-term values, from March to June it was too dry.

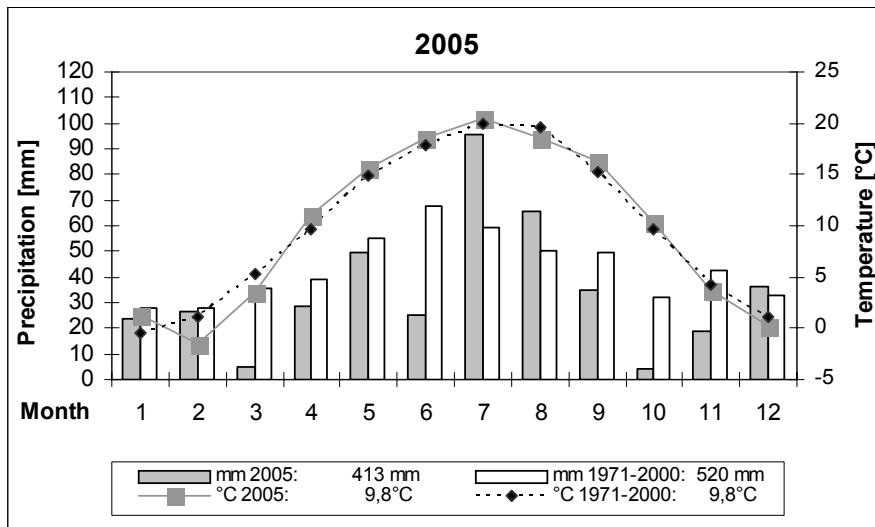

Figure 7: Weather at the site “Raasdorf“ from January to December 2005

3.2 Plant development

The alfalfa crop, sown in late March 2004, developed well as underseed under rye. A lot of alfalfa plants died during winter due to frost in periods without snow cover, with the result of many gaps and a high rate of weed infestation in several plots. In 2005, only two harvests (first one on 13th of June, and the second one on 8th of August) were possible due to the weather situation. A very long cold period in spring reduced the growth rate at the beginning of the vegetation and delayed the first harvest and also the second harvest. In spring 2005, the plant density (see Table 15 in annex) amounted from 271 (variety Sitel) to 284 (variety Tango) plants ha⁻¹. This density dropped from 120 (variety Verko) to 133 (variety Vlasta and Tango) plants ha⁻¹ until summer. There was no difference found between the plant densities of the varieties.

Considering weed and pest infestation no difference was observed between the varieties. Although by inspection a high damage of the alfalfa leaves was observed in the early vegetation period (see Figure 8), not many larvae of the pea and bean weevil were found (see Table 15 in annex).



Figure 8: Pea and bean weevil

1st row left: pea and bean weevil (*Sitona lineatus*); 1st row right: high damage on alfalfa leaves; 2nd row left: moderate damage on alfalfa leaves; 2nd row right: larvae of the pea and bean weevil

Regarding the plant development at the harvest time, no differences between the varieties were found, only the fact of an earlier cutting at the second harvest. This shows the lower blossom rate at the second harvest (see Table 15 in annex).



Figure 9: Colour variation of alfalfa blossoms

Leaf area index increased (see Figure 10) from the first to the second harvest (see Table 15 in annex). This could be the result of an earlier harvest and fewer mature alfalfa plants with more intact leaves at the second harvest.

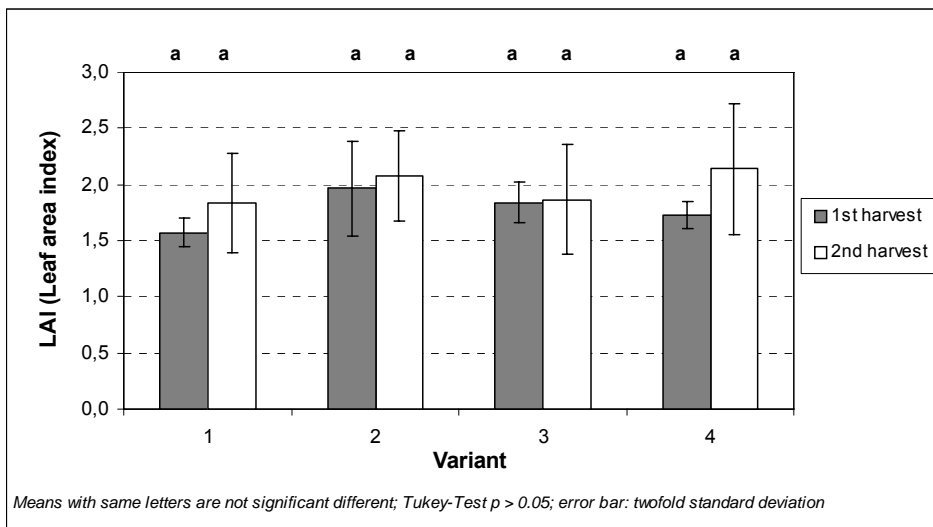

Figure 10: Leaf Area Index (LAI) of alfalfa variants no 1-4 at harvests 1 and 2

Before the first harvest the alfalfa varieties showed an exponential increase of their plant height during the growth period. The image of the second growth period is different. Linear growth in the beginning combined with a digressive phase in the end (before second harvest) was observed (see Figure 11).

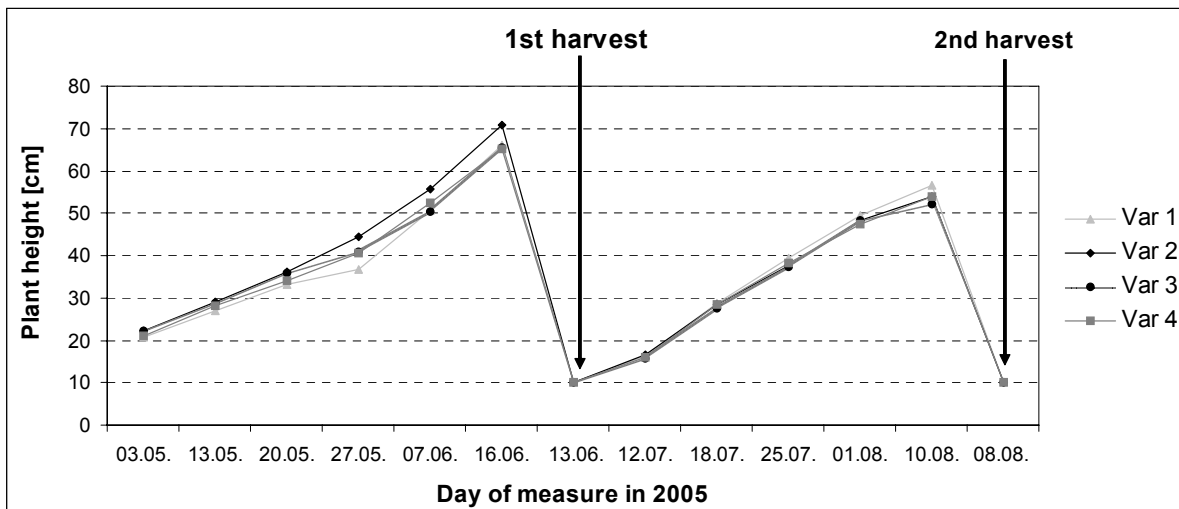
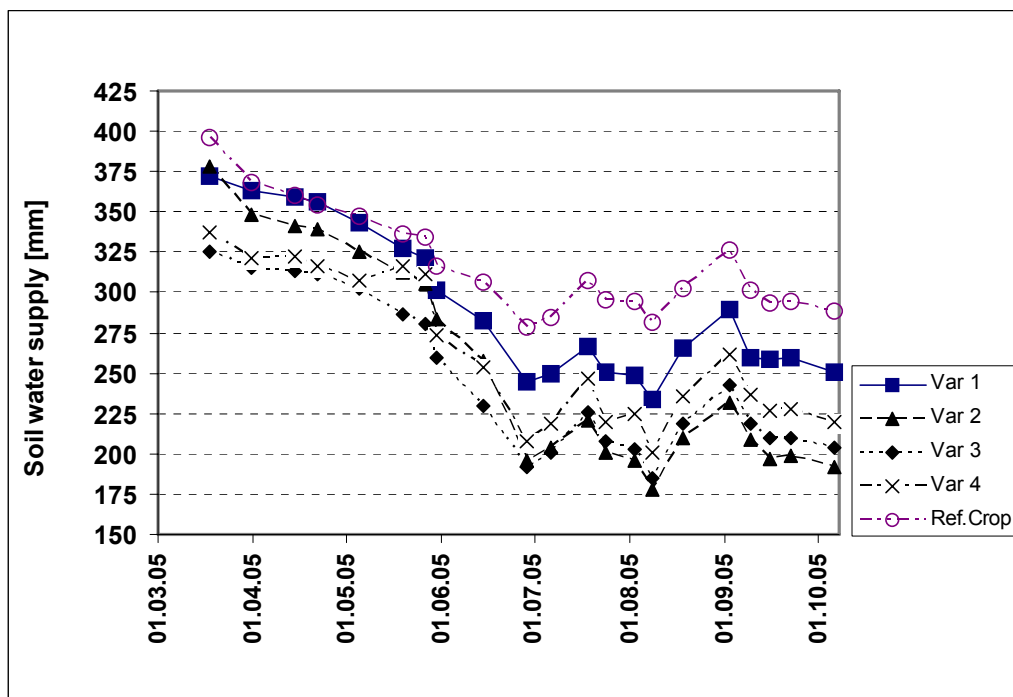

Figure 11: Plant height during the first and the second growth of alfalfa variants no 1-4

3.3 Soil water supply and water availability

Soil water supply ranged from 325 mm to 380 mm within 160 cm soil depth under the alfalfa varieties and was around 400 mm under the reference crop in Mid March 2005 (Figure 12). During the vegetation period 2005, the soil water supply decreased by 120 mm on the average under the varieties Vlasta, Sitel and Verko. Under variety Tango, the decrease was more pronounced (187 mm), whereas under the reference crop, it was smaller (108 mm).



Legend: 1: Vlasta; 2: Tango; 3: Sitel; 4: Verko; Ref. Crop: Reference Crop

Figure 12: Soil water supply within 160 cm soil depth during the vegetation period 2005

Differences in mean soil water values at the beginning (17 March 2005) and end the end of the vegetation period (6 Oct. 2005) could be mainly attributed to an effect of the factor “column” in the experimental design (Table 6).

Table 6: Variance components of soil water supply, 17 March 2005 (dependent Variable: Water 17.3.2005)

Quelle	Sum of squares, Typ III	df	Mean of squares	F	Significance
Corrected Model	36862.063(a)	9	4095.785	5.793	.022
Constant Term	1995862.563	1	1995862.56	2822.753	.000
Var	7904.188	3	2634.729	3.726	.080
Replicate	3651.187	3	1217.062	1.721	.261
Column	25306.687	3	8435.562	11.930	.006
Error	4242.375	6	707.063		
Total	2036967.000	16			
Corrected total variation	41104.438	15			

a R square = .901 (corrected R square = .753)

At the same site, Pietsch (2004: 174 - 180) measured soil water contents under alfalfa crops in two years. Soil water supply within 160 cm soil depth amounted to 264 mm and 276 mm in March 2000 and 2001, respectively. These values are about 70 – 80 mm lower than those of the current BIOfix trial.

The amount of precipitation from beginning of March to end of July was 27 mm, 19 mm, and 61 mm below the long-term average in 2000, 2001, and 2005, respectively (Pietsch, 2004: 23; section 3.1). Thus, in the BIOfix trial in 2005, a greater soil water supply at the beginning of the vegetation period was partly counterbalanced by a lower precipitation during the following months. Still, the total water availability was better in 2005 than in 2000 and in 2001.

3.4 Above and below-ground biomass yield

In the present study, the mean annual shoot dry matter (DM) yield reached 4.5 t ha⁻¹ in 2005 (Figure 13 and 14). At the first harvest, the shoot yield ranged from 2554 kg ha⁻¹ (variety Vlasta) to 3013 kg ha⁻¹ (variety Sitel) (Figure 13). At the second harvest, 1603 kg ha⁻¹ (variety Vlasta) was the lowest and 1827 kg ha⁻¹ (variety Sitel) the highest shoot DM yield (Figure 14). Shoot yield decreased from the first to the second harvest. On the opposite, an increase in root DM biomass could be observed (see Table 16 in annex). No significant differences in root biomass between the varieties were found at both harvests. The yield level at the same site ranged from 6 to 12 t DM ha⁻¹ in 2000 and 2001 (Pietsch 2004: 62-63). Hirth et al. (2001) determined a mean dry matter production of 3.8 t ha⁻¹ for the spring to autumn growth of alfalfa in the extensive dryland in Southern Australia (average annual rainfall 600 mm) during seven years of investigation. The low alfalfa yield in 2005 compared to 2000 and 2001 cannot be ascribed to low water availability in 2005 (Chap. 3.3). Plant development and dates of harvest, however, were retarded in 2005 due to a weak crop after winter and a cold spring in 2005.

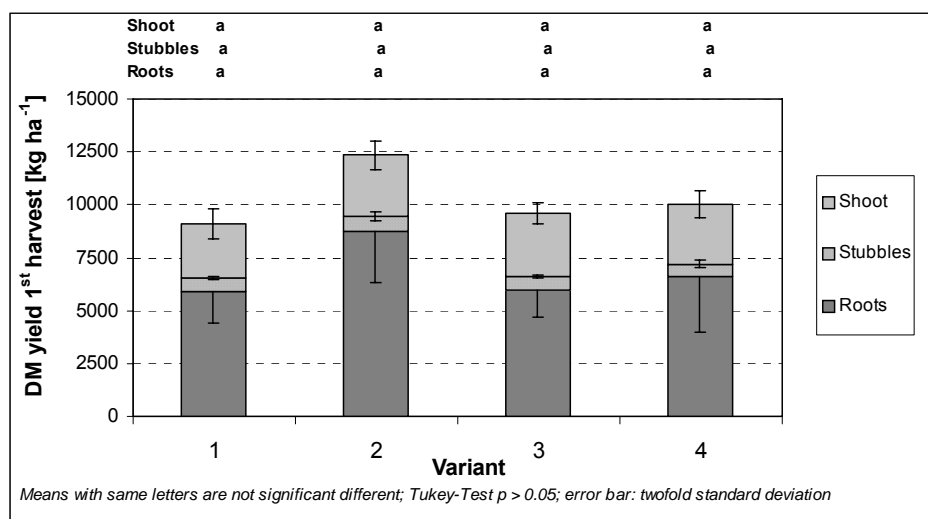

Figure 13: Total plant biomass yield of alfalfa variants no 1-4 at harvest 1

The stubble yield was nearly equal in all varieties both at the first (573 kg ha⁻¹ variety Verko to 697 kg ha⁻¹ variety Tango) and the second harvest (630 kg ha⁻¹ variety Sitel to 681 kg ha⁻¹ variety Verko; Figure 13, Figure 14, Table 18 in annex). This result seems reasonable, since the stubbles were harvested at a height of approximately 10 cm in all varieties and at both harvest periods.

Regarding the root yield, no difference between the varieties was observed. The yield from 0 – 60 cm in the soil ranged from 5889 kg ha⁻¹ (variety Vlasta) to 8757 kg ha⁻¹ (variety Sitel) at the first harvest and from 9773 kg ha⁻¹ (variety Verko) to 12036 kg ha⁻¹ (variety Sitel) at the second harvest. The time span from the first alfalfa harvest (13th of June) to the second (8th of August) was approximately two months. This short time span shows the potential and the importance of the alfalfa plant in organic farming in the continental climatic area to produce a high below-ground biomass. The root biomass increased from 30 (variety Tango) to 100 % (variety Sitel) from the first to the second harvest.

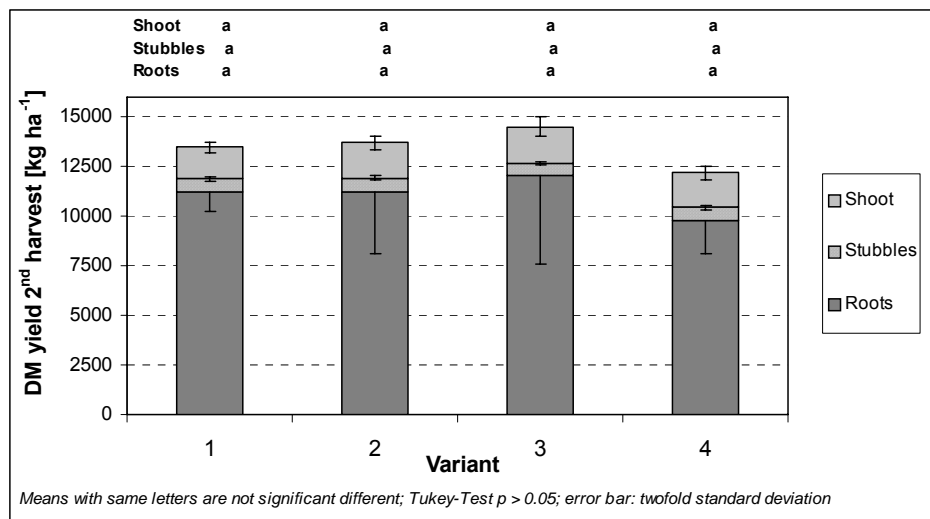

Figure 14: Total plant biomass yield of alfalfa variants no 1-4 at harvest 2

Jung (2003) and Anthes (2005) determined less below-ground than above-ground biomass yield at experimental sites with a relatively high sum of precipitation (Göttingen, Germany: 648 mm annual mean value). At the Raasdorf site Pietsch (2004) and Pietsch et al. (2006a) found twice as much below ground biomass than above ground biomass yield (see Table 7). A possible explanation for that obviously is the reduced water availability to plants during the vegetation period. Plants can transfer assimilates from the shoot to the roots at water stress conditions and the root system will be extended (Antolin et al. 1995; Ehlers 1996:167). At the Raasdorf site, the sum of precipitation was reduced compared to the annual mean value by -16% in the year 2005 (BIOfix-Project and Pietsch et al. 2006a in the 2. year of utilization), by -6% in the year 2004 (Pietsch et al 2006a in the 1. year of utilization) and by -10% in the years 2001 and 2002 (Pietsch 2004 in the 2. year of utilization).

Table 7: Root and shoot dry matter yield of alfalfa in the 1. and 2. year of utilization at different sites

Reference	Yr	Roots H1 [t ha ⁻¹]	Roots H2 [t ha ⁻¹]	Roots H3 [t ha ⁻¹]	Shoot H1 [t ha ⁻¹]	Shoot H2 [t ha ⁻¹]	Shoot H3 [t ha ⁻¹]
Jung (2003)* Hannover/Göttingen (UJ)	1+2	-	-	4,4	-	-	9,2
Anthes (2005) Göttingen (FS)	1	2,3	4,7	5,1	3,0	5,8	7,2
Pietsch (2004) Raasdorf (UJ)	1	3,0	3,3	3,6	4,7	1,9	2,1
	2	3,0	3,9	4,3	6,5	2,2	1,7
Pietsch et al. (2006a) Raasdorf (SS)	1	-	3,4	-	3,9	1,3	-
	2	4,1	4,1	-	2,7	1,4	-
BIOfix-Project Raasdorf (US-UJ)	1	6,8	11,1	-	2,8	1,7	-

Yr: Year of utilization; H1: harvest 1, H2: harvest 2, H3: harvest 3; FS: Spring sowing as main crop; US-UJ: Undersown crop in rye, sowing in spring, 1. year of utilization in the following year; UJ: sowing in summer as main crop; *Shoot DM yield of all harvests, mean of 1. and 2. year of utilization at 3 different sites; **: mean of all varieties

The mean DM yield ratio (proportion of above to below ground biomass) of alfalfa plants was 0.52 at harvest 1 and 0.22 at harvest 2 (see Table 8). Since the nitrogen content in the shoots was higher than in the roots, the N yield ratio (0.80 at harvest 1, 0.32 at harvest 2) was increased compared to the DM yield ratio. In general the DM yield ratio decreased from harvest 1 to harvest 2. The ratios calculated in the present project were similar to the ratios in the investigation of Pietsch et al 2006b (year 2005, mean value of 13 alfalfa varieties).

Table 8: Biomass DM and nitrogen yield ratio (above-ground-to-below-ground ratio) of alfalfa variants at the Raasdorf site in the year 2005

Variant / Variety Reference	DM yield ratio		N yield ratio	
	Harvest 1	Harvest 2	Harvest 1	Harvest 2
BIOfix-Project:				
1 / Vlasta	0.55	0.20	0.84	0.31
2 / Tango	0.41	0.22	0.65	0.33
3 / Sitel	0.60	0.20	0.90	0.28
4 / Verko	0.51	0.25	0.80	0.36
<i>Mean value</i>	<i>0.52</i>	<i>0.22</i>	<i>0.80</i>	<i>0.32</i>
Pietsch et al. (2006b)	0.62	0.35	0.96	0.41



Figure 15: Alfalfa plants at harvest

3.5 Nitrogen fixation and yield

The nitrogen content in the shoots ranged from 3.2 % to 3.6 % N at harvest 1 from 3.4 % to 3.8 % N at harvest 2. In the stubbles 2.2 - 2.4 % N and 2.0 - 2.2 % N were determined at harvest 1 and 2, respectively. The nitrogen concentration in the roots was 1.8 - 2.1 % N at harvest 1 and 2.0 - 2.2 % N at harvest 2. No significant differences in nitrogen contents in shoots, stubbles and roots between the varieties were found at both harvests (see Table 19 in annex).

The total nitrogen yield increased more or less at the same time as the dry matter yield from the first to the second harvest (Figure 16, Figure 17, Table 19 in annex). Regarding the shoot, the nitrogen yield showed the same picture as the dry matter. The higher nitrogen yield at the first harvest results from a higher dry matter yield. At the first harvest, the nitrogen shoot yield amounted to 82 kg ha⁻¹ (variety Vlasta) - 103 kg ha⁻¹ (variety Tango) and at the second harvest to 60 kg ha⁻¹ (variety Vlasta) - 63 kg ha⁻¹ (variety Verko).

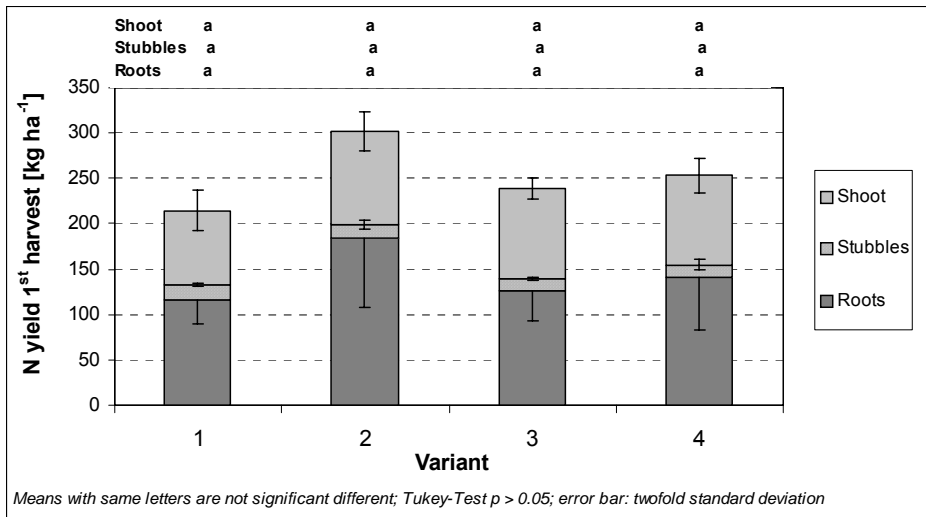

Figure 16: Nitrogen yield of the total plant biomass of alfalfa variants no 1-4 at harvest 1

The nitrogen yield of the stubbles fluctuated in a very narrow range (Table 19 in annex): From 14 kg ha^{-1} (variety Verko) to 16 kg ha^{-1} (variety Vlasta) at the first harvest, and from 13 kg ha^{-1} (variety Sitel) to 15 kg ha^{-1} (variety Tango) at the second harvest. Like the root dry matter yield, the root nitrogen yield increased between 30 (variety Tango) and 110 % (variety Vlasta) from the first to the second harvest (Table 19 in annex). The lowest nitrogen yield ranged from 116 kg ha^{-1} (variety Vlasta) to 183 kg ha^{-1} (variety Tango) at the first harvest, and from 216 kg ha^{-1} (variety Verko) to 260 kg ha^{-1} (variety Sitel) at the second harvest. A higher root nitrogen yield at the second harvest is the result of a higher root dry matter, which was shown above.

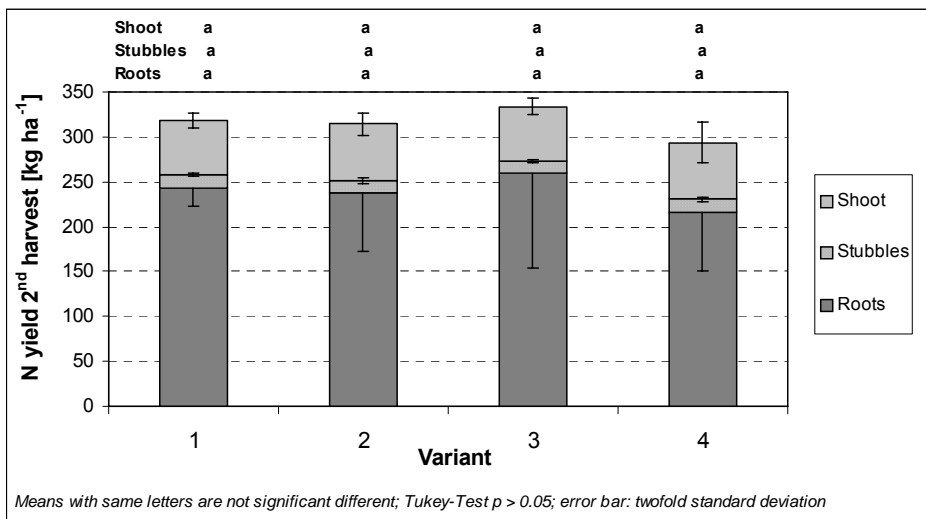

Figure 17: Nitrogen yield of the total plant biomass alfalfa variants no 1-4 at harvest 2

Regarding the nitrogen fixation (N_{fix}), no changes between the first and the second harvest were found (see Figure 18, Figure 19 and Table 20 in annex). No differences between the varieties occurred as well. At the first harvest, the nitrogen fixation ranged between 132 kg

ha⁻¹ (variety Vlasta) and 210 kg ha⁻¹ (variety Tango). For the second harvest a nitrogen fixation between 150 kg ha⁻¹ (variety Vlasta) and 219 kg ha⁻¹ (variety Sitel) was observed.

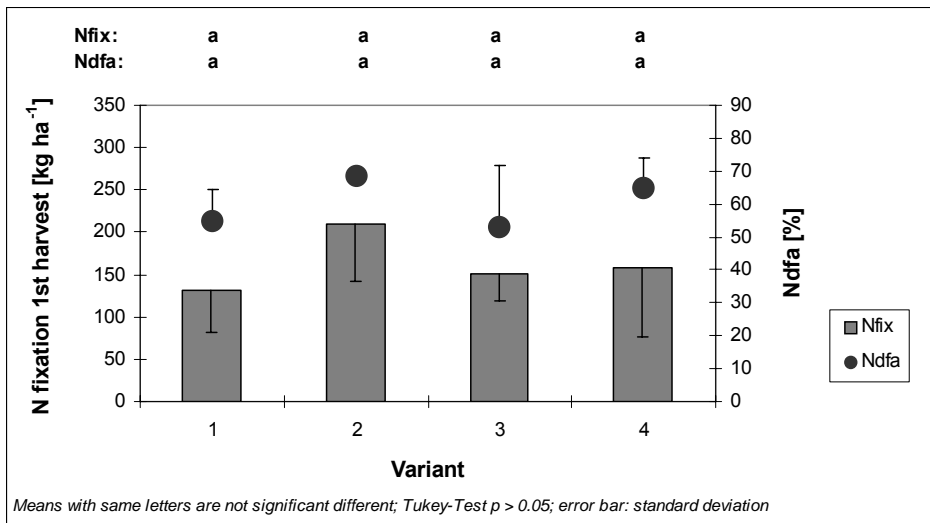

Figure 18: Nitrogen fixation (N_{fix}) and nitrogen derived from the atmosphere (N_{dfa}) of alfalfa variants no 1-4 at harvest 1

Also the nitrogen derived from the atmosphere (N_{dfa}) indicated no differences (Figure 18 and Figure 19). The N_{dfa} values reached 53% (variety Sitel) to 68% (variety Tango) at the first harvest and 56% (variety Vlasta) to 76% (variety Tango) at the second harvest.

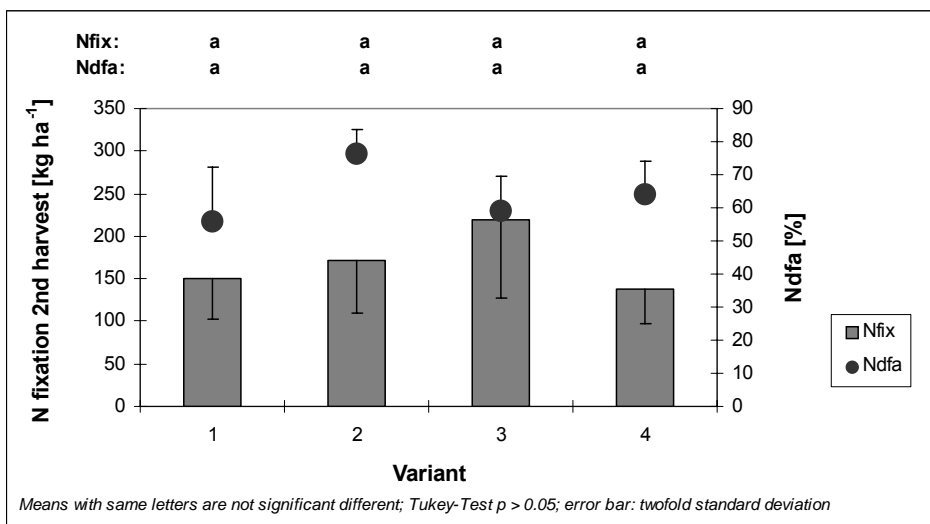

Figure 19: Nitrogen fixation (N_{fix}) and nitrogen derived from the atmosphere (N_{dfa}) of alfalfa variants no 1-4 at harvest 2

The inorganic soil nitrogen content under the alfalfa variants was very low (0-90 cm: 8 – 13 kg NO₃-N ha⁻¹; see Figure 20) at the first harvest.

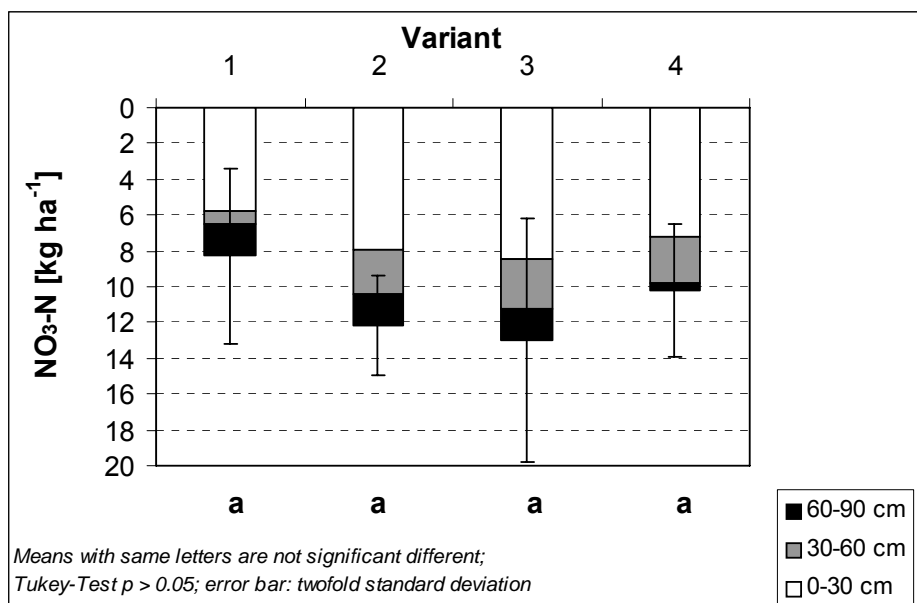

Figure 20: Inorganic soil nitrogen (NO₃-N) of alfalfa variants no 1-4 at harvest 1

In the present study, compared with previous investigations at the Raasdorf site, we observed a clear inverse relation ($r = -0.80$) between inorganic soil nitrogen and nitrogen fixation (see Table 9). In years with low inorganic contents in soil (2001 and 2005), the nitrogen fixation was higher than in years (2000 and 2004) with high nitrogen contents in soil. The negative relationship between mineral-N contents in soil and nitrogen fixation rates is well known. Symbiotic nitrogen fixation is an energy consuming process, thus legumes obtain less of their N₂ requirement from the atmosphere if there is an adequate supply available from the soil. Thus, factors that enhance the soil mineral N supply (e.g. mulching) will lead to a decline of the quantity of fixed N₂. Therefore, N_{dfa}-values of 60-70% are relatively high for alfalfa green manure utilization systems.

Table 9: Nitrogen fixation (N_{fix}), Nitrogen derived from atmosphere (N_{dfa}) and inorganic soil nitrogen (NO₃-N) of alfalfa (mean value) at harvest 1 at the site Raasdorf according to Pietsch (2004) in the year 2000 and 2001, Hrbek (2005) in the year 2004 and in the year 2005 (BIOfix-Project)

Year	N _{fix} [kg ha ⁻¹]	N _{dfa} [%]	NO ₃ -N [kg ha ⁻¹]	Reference
2000	61*	48	50	Pietsch (2004)
2001	110*	59	6	Pietsch (2004)
2004	87	70	48	Hrbek (2005)
2005	163	60	8-13	BIOfix project

*2000 and 2001: Nitrogen fixation in plant shoot; 2004 and 2005: nitrogen fixation in total plant

3.6 Evapotranspiration

Evapotranspiration of the alfalfa crops ranged from 302 mm to 374 mm from April to August 2005 (Figure 21). The values calculated according to the Penman Monteith method and by the water balance approach were the same, but variability was greater for the water balance approach based on soil water contents and precipitation than for the Penman Monteith estimation based on weather data. The four alfalfa variants did not differ in their Evapotranspiration according to the Penman Monteith method, but Evapotranspiration according to the water balance approach of variant 2 (variety Tango; 374 mm) was significantly greater than that of variant 4 (variety Verko; 302 mm). This relates to a more pronounced decrease in soil water supply in variant 2 (Figure 12).

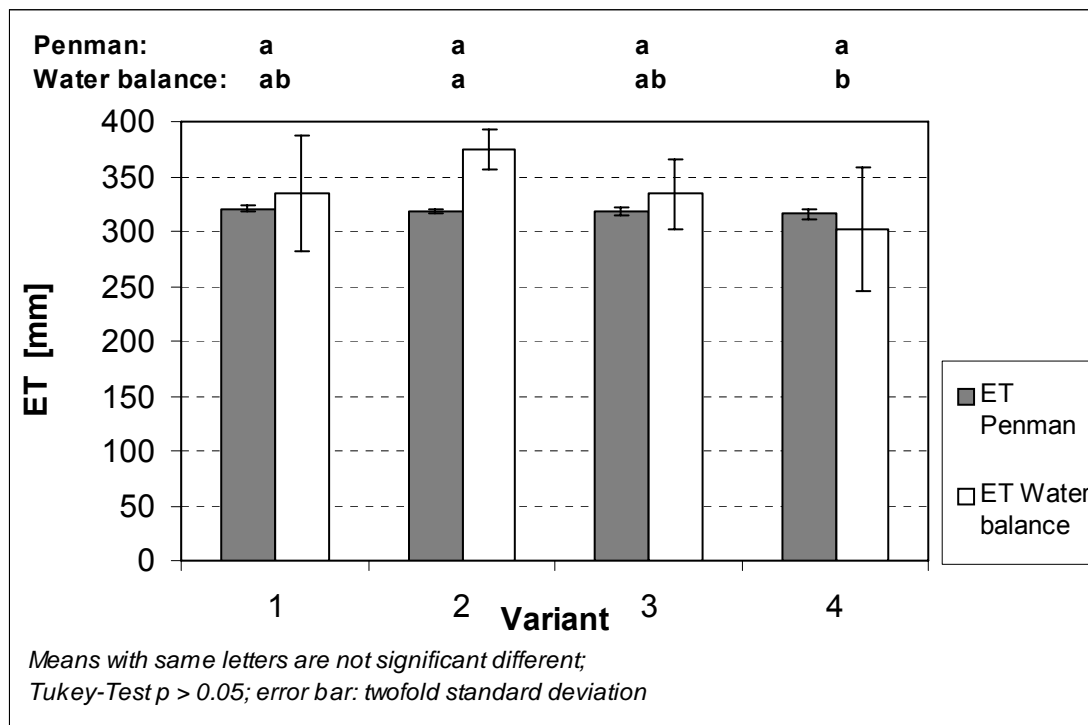

Figure 21: Evapotranspiration of alfalfa variants no 1-4 from April to August 2005 calculated according to the Penman Monteith method and the water balance approach

The four alfalfa variants also did not differ in their Evapotranspiration and ETC from begin of the period to the first harvest 1. The variant 2 showed a higher Evapotranspiration value (188 mm) from harvest 1 to harvest 2, than the other variants (see Table 10).

Table 10: Evapotranspiration (ET in mm) and Evapotranspiration coefficient (ETC in L kg⁻¹) of alfalfa variants no 1-4 during two time intervals calculated according to the water balance approach

Time Interval	Parameter	Var 1	Var 2	Var 3	Var 4
13 April – 13 Jun 2005 (begin period – harvest 1)	ET (Stddev)	173 ^a 14	179 ^a 28	177 ^a 28	145 ^a 23
	ETC (Stddev)	715 ^a 200	666 ^a 308	594 ^a 88	534 ^a 149
14 Jun – 7 Aug 2005 (harvest 1 – harvest 2)	ET (Stddev)	155 ^a 33	188 ^b 22	152 ^a 14	155 ^a 33
	ETC (Stddev)	979 ^a 219	1109 ^a 335	868 ^a 195	926 ^a 303

Stddev: standard deviation; means with same letters are not significant different; Tukey-Test $p > 0.05$

At the same site, Pietsch (2004) assessed evapotranspiration of alfalfa crops during the vegetation periods in 2000 and 2001. In 2001, average values of the Penman Monteith method and the water balance approach were in a similar range (Table 11). In 2000, however, values of the Penman Monteith method were higher and those of the water balance approach were lower than that of the current BIOfix study. Badaruddin und Meyer (1989) measured a total water use as soil water extraction from 0 to 2.2 m soil depth of green manure alfalfa at two sites and over two years of 405 mm per year.

Table 11: Evapotranspiration (mm) of alfalfa variants no 1-4 at the site Raasdorf according to Pietsch (2004: 51 - 54) in the year 2000 and 2001 and in the year 2005 (BIOfix-Project)

Time Interval	Penman Monteith method	Water balance approach
22 March – 4 Sept. 2000	446 (2.67 per day)	273 (1.63 per day)
27 March – 1 Aug. 2001	324 (2.53 per day)	302 (2.36 per day)
13 April – 31 Aug 2005	318 (2.26 per day)	336 (2.38 per day)

The rainfall at the trial site in Raasdorf from April to August 2005 was just 264 mm (in year 2000: 323 mm, in year 2001: 281 mm). In the absence of rainfall in summer (precipitation at harvest 1: 0.3-1 mm per day; harvest 2: 0.6 mm per day), evapotranspiration from alfalfa was negligible (mean of variants no 1-4 at harvest 1: 2.4-3.3 mm per day, harvest 2: 3.3 mm per day), as calculated from changes in soil water storage to a depth of 160 cm. When summer rainfall occurred, alfalfa used all of it for evapotranspiration (see Figure 22).

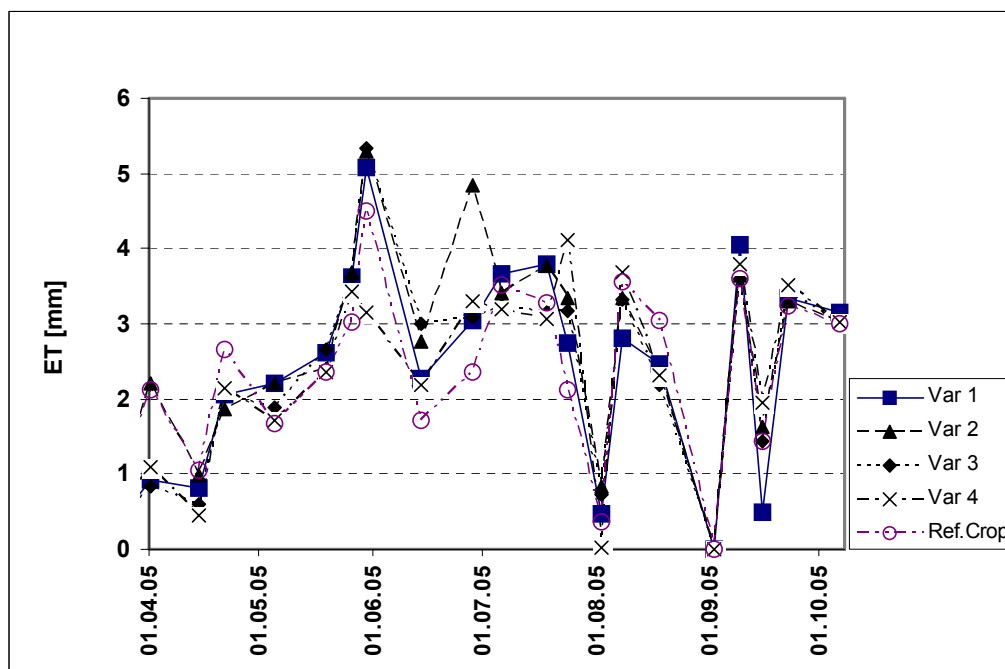
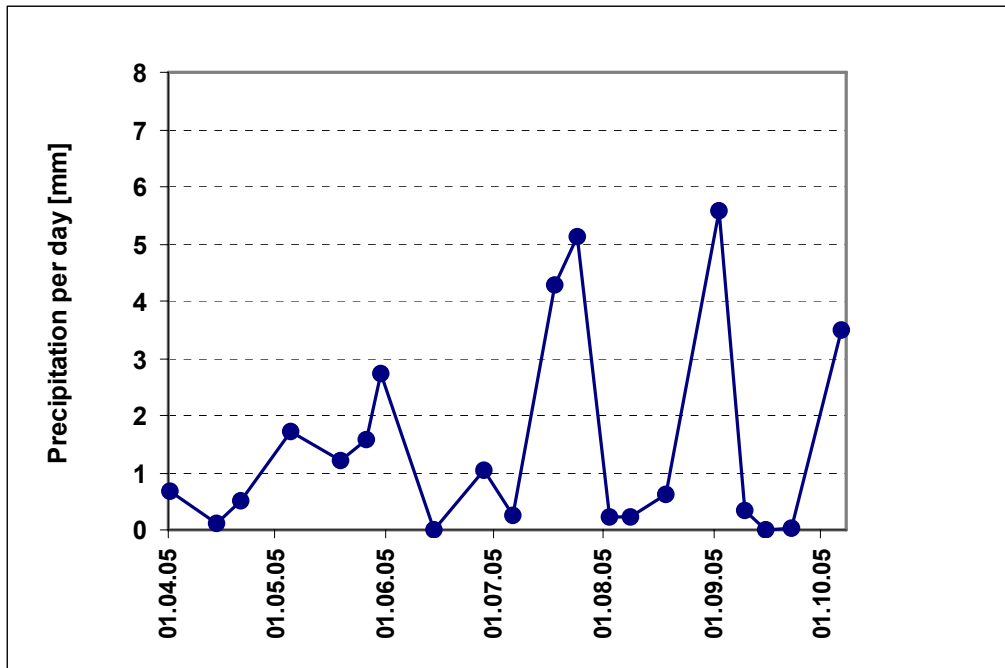

Figure 22: Precipitation and Evapotranspiration per day of alfalfa variants no 1-4 during the vegetation period 2005 (Evapotranspiration according to the water balance approach)

3.7 Water use efficiency

Water use efficiency of productivity (WUE_p):

The evapotranspiration coefficient ranged from 659 to 807 L (kg DM)⁻¹ and did not differ with the two calculation methods (Figure 23). Both crop DM yield (Figure 13 and Figure 14) and

Evapotranspiration according to the Penman Monteith method (Figure 21) were not different for the alfalfa varieties. Consequently, also the evapotranspiration coefficient was the same for all varieties.

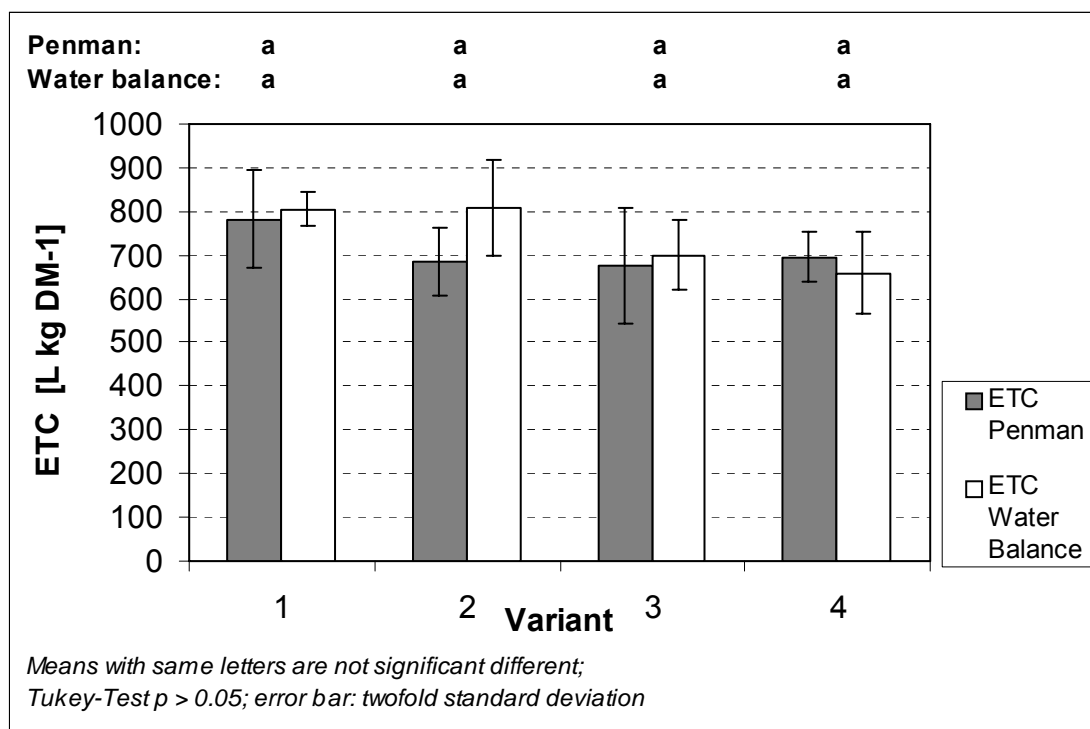

Figure 23: Evapotranspiration coefficient of alfalfa variants no 1-4 from April to August 2005
(calculated according to the Penman Monteith method and the water balance approach)

Compared to the results found by Pietsch (2004) at the same site in 2000 and 2001 (Table 12), values in 2005 were almost doubled. This divergence can be explained by a significantly higher yield level in 2000 and 2001 (6 to 12 t ha⁻¹, sum of three harvests; Pietsch, 2004: 62-63) compared to 2005 (4.2 to 4.8 t ha⁻¹, sum of two harvests; Figure 13 and Figure 14). Evapotranspiration, on the other hand, hardly differed between the years (Table 11).

Table 12: Evapotranspiration coefficient (L kg⁻¹) of alfalfa (mean of variants no 1-4) at the site Raasdorf
according to Pietsch (2004: 54, 218) in the year 2000 and 2001 and in the year 2005 (BIOfix-Project)

Time Interval	Penman Monteith method	Water balance approach
22 March – 4 Sept. 2000	459	459
27 March – 1 Aug. 2001	265	272
13 April – 31 Aug. 2005	710	743

The tested alfalfa varieties reached $13.5 \text{ kg ha}^{-1} \text{ mm}^{-1}$ in 2005 in their water use performance (mean value of variants no 1-4, according to the water balance approach). There was no difference between the varieties. Reports of alfalfa WUE range from 9.7 to $18.1 \text{ kg ha}^{-1} \text{ mm}^{-1}$ (Sheaffer et al. 1988, Bolger and Matches 1990, Hirth et al. 2001, Carter and Sheaffer 1983, Badaruddin und Meyer 1989). Investigations comparing WUE of different alfalfa varieties are not known. Ljungkull (1982) reported lysimeter ET rates for well watered alfalfa of 3.1 to 10.22 mm per day , Tanner and Pelton (1960) determined ET values for an alfalfa-bromegrass mixture of 1.0 to 9.00 mm per day . Water use rates for alfalfa with non-limiting soil water ranged from 5.3 to 10.0 mm per day during July, August and September (Carter and Sheaffer 1983a), unirrigated alfalfa plants averaged 2.6 mm of ET daily with a midday total plant water potential ranging from -3.1 to below -4.0 MPa during this period. The authors assumed that these high ET rates despite the substantial plant water deficits are evidently due either to the apparent of complete stomatal closure or to the high cuticular conductance of water-stressed alfalfa (Carter and Sheaffer 1983b). The ET from alfalfa in the present study reached 2.4 to 3.3 mm per day (mean of variants no 1-4). It can be assumed that variety differences in water use and water use efficiency become more obvious as drought becomes more distinct. Measurement of ET and ET coefficients under conditions of induced water stress may be helpful to reveal differences between varieties that are otherwise obscured by spatial variability or other factors.

In line with Passioura (1994), we found a positive correlation between shoot DM yield (harvests 1 and 2) and Evapotranspiration of the alfalfa variants during the vegetation period from April to August 2005 ($r^2 = 0.5097^{**}$; see Figure 24).

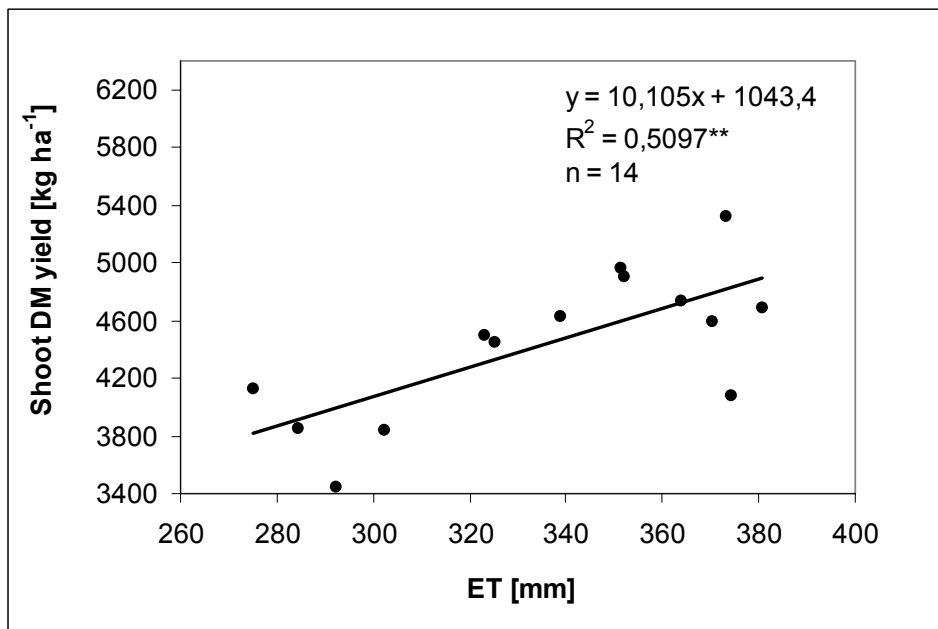

Figure 24: Shoot DM yield and Evapotranspiration of alfalfa variants no 1-4 during the vegetation period 04-08/2005 (Evapotranspiration according to the water balance approach)

Water use efficiency of photosynthesis (WUE_{ph}):

Carbon isotope discrimination (Δ) should be negatively associated with WUE because the CO_2 assimilation to stomatal conductance ratio is inversely related to Δ (Johnson and Tieszen 1994). The authors reported that Δ and shoot WUE were negatively correlated ($r = -0.63$ to -0.73) in alfalfa. In the present study we found no correlation between Δ and WUE calculated by water balance (see Table 13).

Table 13: Water use efficiency (WUE_p , calculated by water balance), Isotope discrimination, Evapotranspiration (ET), Harvest index (HI) and shoot yield of alfalfa variants no 1-4 at harvests 1 and 2 in 2005

Variant / Variety	WUE_p ($kg\ ha^{-1}\ mm^{-1}$)	$\Delta^{13}C$ (‰)	ET (mm)	HI	Shoot yield ($kg\ ha^{-1}$)
1. Harvest					
1 / Vlasta	14,7 ^a	19,9 ^b	173 ^a	0,40 ^a	2554 ^a
2 / Tango	16,9 ^a	20,5 ^a	179 ^a	0,32 ^a	2911 ^a
3 / Sitel	17,1 ^a	19,9 ^b	177 ^a	0,46 ^a	3013 ^a
4 / Verko	19,7 ^a	20,1 ^{ab}	145 ^a	0,42 ^a	2828 ^a
2. Harvest					
1 / Vlasta	10,6 ^a	19,9 ^a	155 ^b	0,14 ^a	1603 ^a
2 / Tango	9,7 ^a	19,7 ^a	188 ^a	0,15 ^a	1773 ^a
3 / Sitel	12,0 ^a	19,5 ^a	152 ^b	0,16 ^a	1827 ^a
4 / Verko	11,8 ^a	19,6 ^a	155 ^b	0,17 ^a	1737 ^a

WUE_p : water use efficiency of productivity according to the water balance approach; $\Delta^{13}C$ ‰: Carbon isotope discrimination; ET: Evapotranspiration according to the water balance approach, HI: harvest index (proportion of harvested above plant material to total produced biomass). Tukey-Test $p > 0.05$: means with same letters are not significant different.

Since water use efficiency (WUE) is negatively related to the $\delta^{13}C$ -value of the plant, variants 1 and 3 have a significantly higher WUE than variant 2 at harvest 1 (Figure 25). A higher WUE means that these variants used the available water more efficiently than the other. In a field experiment comparing nine alfalfa cultivars, Ray et al. (1998) also found significant differences in carbon isotope discrimination between the varieties. The ranking of Δ among forage genotypes has been reported to be relatively stable across a range of production environments (Johnson and Bassett 1991, Johnson and Tieszen 1994). Therefore, we suggest that under water-stress conditions the ranking of the tested cultivars regarding to Δ should be similar. Although we found some differences at harvest 1, our results indicate limited variation for Δ among the four alfalfa varieties. At harvest 2, we found no differences in the $\delta^{13}C$ -value between the four variants.

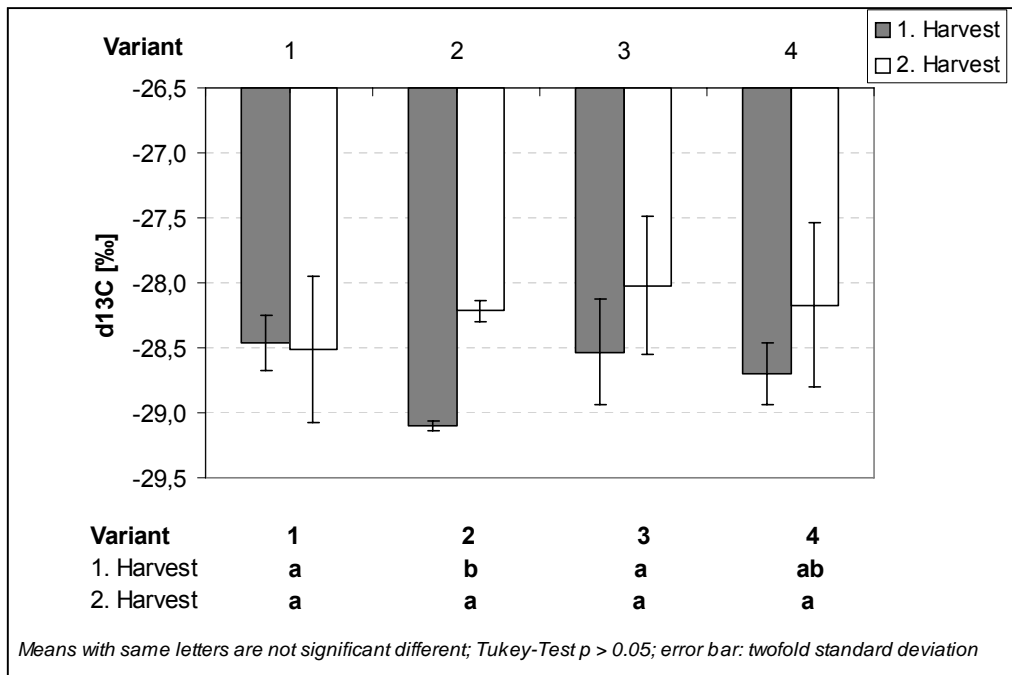

Figure 25: $\delta^{13}\text{C}$ -value of alfalfa variants no 1-4 at harvests 1 and 2

3.8 Total water potential (Ψ_t) and results from pressure-volume-curves

When tested with the Tukey-Test total water potentials at noon showed no significant differences between the means of the four alfalfa variants at both harvests due to relatively high standard deviations (see Table 14). However, total water potential tended to be less negative in variant 1 than in the other variants. Brown and Tanner (1981) also reported large between-plant variability in total water potential of field-grown alfalfa. The authors supposed that a part of this between-plant variability was due to variation in 1st-year root development.

Table 14: Total water potential at noon of alfalfa variants no 1-4 (mean value of 4 plots per variant and 3 plants per plot) at harvests 1 and 2

Harvest	Var.	Ψ_t^* (-MPa)	Stddev	Tukey
1	1	1,03	0,33	a
	2	1,46	0,23	a
	3	1,78	0,40	a
	4	1,59	0,48	a
2	1	1,44	0,33	a
	2	1,87	0,15	a
	3	2,03	0,29	a
	4	1,88	0,52	a

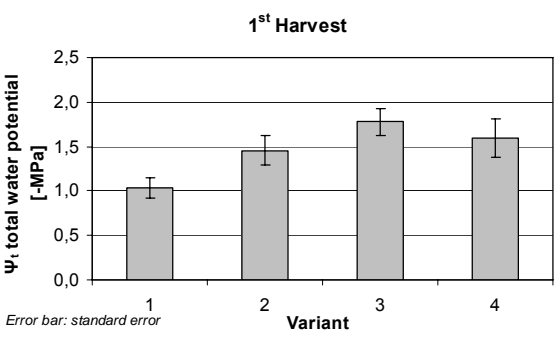
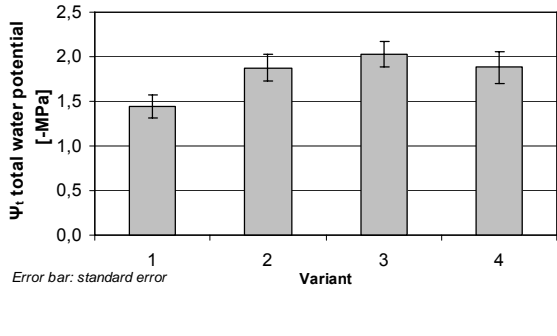
* Ψ_t : Total water potential at noon (mean value of 4 plots per variant and 3 plants per plot); Var.: variant; Stddev: standard deviation; Tukey-Test $p > 0.05$: means with the same letter are not significantly different; Bars in graphs: standard error of the mean

Total water potential at any point in the plant is defined as the sum of soil water potential, gravitational potential, and frictional potential. Since gravitational potential is not relevant in herbaceous plants, total water potentials results from the components soil water potential and frictional potential. Total water potentials of the alfalfa variants at harvest 1 (mean of variants no 1-4: -1.47 MPa) were less negative than at harvest 2 (mean of variants no 1-4: -1.81 MPa). This difference could be caused by a decrease in soil water potential or an increase in frictional potential. Frictional potential increases, when transpiration is high. Since temperature and saturation deficit were lower and humidity was higher at harvest 2 than at harvest 1, transpiration could not be higher at harvest 2 (according to estimated Evapotranspiration; see Table 12). We conclude that the more negative values of total water potential at harvest 2 compared to harvest 1 resulted from soil water deficits (see Table 15). This result is in agreement with Luis et al. (1999) who observed that alfalfa plants grown under soil water deficit reached more negative total water potentials. Taylor (1952) found greatest alfalfa herbage production with soil water potentials higher than -0.2 MPa (= -2000 hPa). The alfalfa growth rate decreased to 60-75 % when soil water potential dropped below -0.25 MPa in 25-50 cm soil depths (Kemper and Amemiya 1957).

Table 15: Climatic parameters, saturation deficit and soil water potential at the continuous measuring device in field plot 10 at harvests 1 and 2

Harvest	Temp. [°C]	Humid. [%]	Wind [m s ⁻¹]	Sat. deficit [-hPa]	Soil water potential [-hPa]					
					10	30	80	120	140	160 cm
1	21,6	53	4,5	12,1	1438	489	382	---	239	704*
2	16,9	63	1,8	7,2	1865	2529	---	792	>800	>800

Temp., Humid., Wind: daily mean temperature; humidity and wind velocity; Sat. deficit: saturation deficit; Soil water potential at 6:00 morning: harvest 1: data of the continuous measuring device from Rinnofer et al. (2005); harvest 2: data of continuous measuring device in field plot 10; *: data of 27.5.

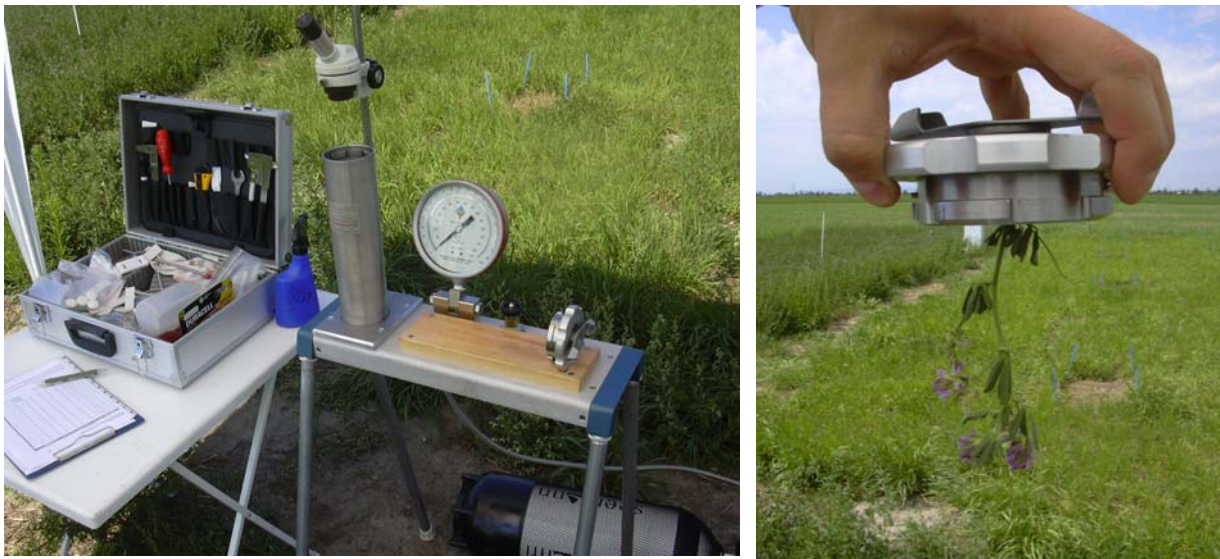

Figure 26: Measuring water potential in the field
Left: Pressure chamber in the field; Right: Alfalfa stem fixed in insertion held

The transpiration-rate is determined by the difference in water availability in the atmosphere and soil and the resistance to water movement into, through, and out of the plant (regulated by stomatal conductance). Evaporation is dependent on the saturation deficit of the air, which is given by the difference between the saturation vapour pressure at the surface temperature and the actual vapour pressure of the air. The saturation vapour concentration increases with increasing temperature and decreasing air humidity (Figure 35 and Figure 36 in annex). With an increase of the saturation deficit, the potential evapotranspiration (ET_0 , calculated with the Penman-Monteith method) also increased (see Figure 27).

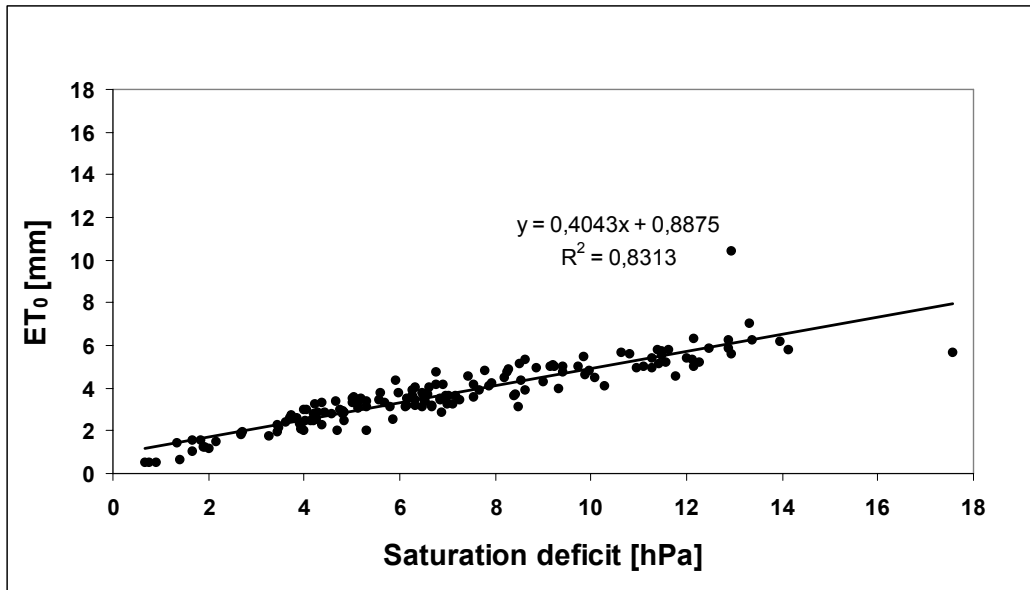

Figure 27: Saturation deficit and potential Evapotranspiration

At the first harvest, total water potentials measured at noon were distinctly more negative than the osmotic potentials at the turgor loss point in variants 3 and 4 which means that no positive turgor remained in these variants (Figure 28, left). In variant 2, total water potentials and osmotic potentials reached almost the same values. Thus it may be assumed that variant 2 acted near the turgor loss point but did not really suffer from drought stress. Variant 1 only was able to maintain positive turgor under field conditions (Figure 28, left). At the second harvest, total water potentials of variants 3 and 4 were less negative than the osmotic potential at the turgor loss point (Figure 28, right). Drought conditions were obviously not severe enough to cause wilting. In contrast, total water potentials of variants 1 and 2 were near or slightly below the osmotic potentials at the turgor loss point.

Total water potential (Ψ_t) and its components osmotic potential (Ψ_o) and turgor (or pressure) potential (Ψ_p) are linked via following equation:

$$(-)\Psi_t = (-)\Psi_o + (\pm)\Psi_p$$

Formula 10

This means that values of turgor potential in a plant cell or plant organ will remain positive as long as osmotic potential stays more negative than total water potential. Turgor potential is a control factor for many processes in plant metabolism (e.g. plant growth, stomatal opening). Thus it is a crucial advantage of plants to maintain positive values of turgor potential under restricted water supply.

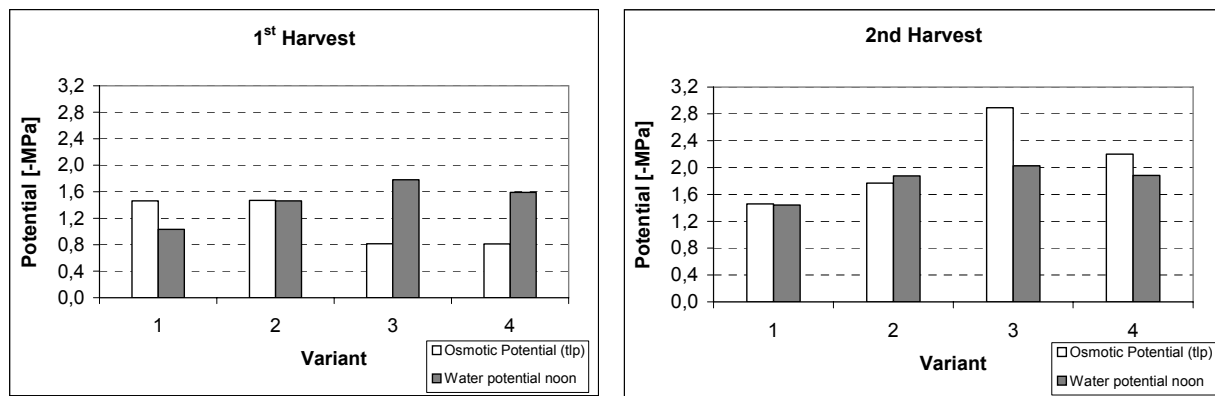

Figure 28: Osmotic Potential at the turgor loss point and total water potential at noon of alfalfa variants no 1-4 at harvests 1 and 2

The stems of alfalfa are very fragile, therefore it was not possible to measure more than 7 data pairs of the same stem with the pressure chamber. Since more values are necessary to generate a pressure-volume curve, we combined the values from all replications tested of each variant in one curve. Consequently, we could not investigate possible differences between the variants with statistic methods. Results from pressure-volume-curves showed that, at harvest 1, variants 3 and 4 reached less negative osmotic potentials at full saturation ($\Psi_{o(sat)}$) than variants 1 and 2 but more negative values of $\Psi_{o(sat)}$ at harvest 2 (see Table 16). This tendency was clear, but for the reason mentioned above statistically not proven. We suppose that variants 3 and 4 accumulated more osmotically active substances in the protoplasts than the other two variants at harvest 2. This could be a hint that variants 3 and 4 showed some osmotic adjustment under water deficit conditions. Grousse et al. (1996) reported that proline concentration of the phloem sap in alfalfa plants which reached the most negative total water potential values (-2.0 MPa) was about 60 times higher compared to non-water-stressed plants. The most common hypothesis considers proline as an osmoticum and a protective agent for cytosolic enzymes and membrane structures (Lahrer et al. 1993). Guo et al. (2005) observed that proline accumulation in leaves of the alfalfa variety Ameristand was higher than in the other eight alfalfa varieties tested and suggested that Ameristand was more drought resistant than the other varieties.

Table 16: Osmotic potential at full saturation of alfalfa variants no 1-4 (mean value of 4 plots per variant) at harvests 1 and 2 (data calculated from pressure-volume curves, type II transformation)

Variant / Variety	Harvest 1 $\Psi_{o(sat)}$ MPa	Harvest 2 $\Psi_{o(sat)}$ MPa
1 / Vlasta	-0,79	-1,16
2 / Tango	-0,67	-1,15
3 / Sitel	-0,42	-1,70
4 / Verko	-0,43	-1,50

$\Psi_{o(sat)}$: Osmotic potential at full saturation

Plots of turgor potential (calculated from pressure-volume curves as the difference between total water potential and osmotic potential) versus total water potential allow analysis of the whole turgor range. At harvest 1, maximum turgor was only 0.4 MPa in variants 3 and 4

whereas in variants 1 and 2 approximately 0.7 MPa (Figure 29). Results of harvest 2 were different: For variants 3 and 4 distinctly higher values of maximum turgor (variant 3: 1.7 MPa, variant 4: 1.4 MPa) were derived compared to variants 1 and 2 (1.1 MPa; Figure 30).

Total water potential at which turgor loss sets on was derived from the intercept of the regression line with the x-axis (Figure 29 and Figure 30). At the first harvest, variant 2 was able to maintain positive turgor to more negative water potentials (-1.8 MPa) than the other variants. At the second harvest, variant 3 lost its turgor at water potentials of -3.0 MPa, the other variants in the range between -2.0 and -2.5 MPa.

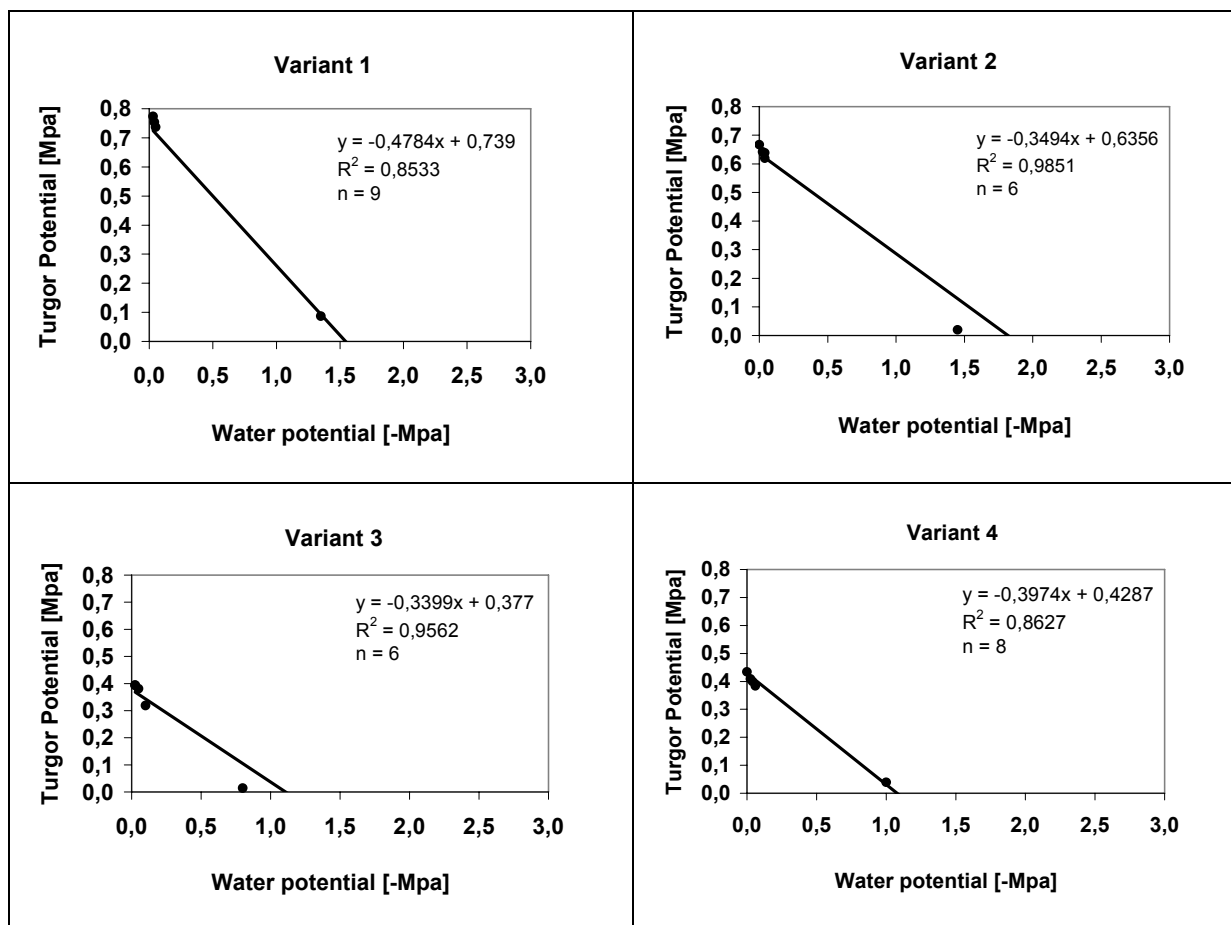

Figure 29: Turgor potential and Water potential of alfalfa variants no 1-4 at harvest 1

For variants 3 and 4, results of osmotic potential at full saturation and at the turgor loss point were quite different at harvest 2 compared to harvest 1. This difference may be due to osmotic and elastic adjustment responses which enabled plants to improve their turgor maintenance at harvest 2. To some extent, the difference may also be due to scarcity of data available (n = 6 to 8) at harvest 1 causing underestimation of turgor potential.

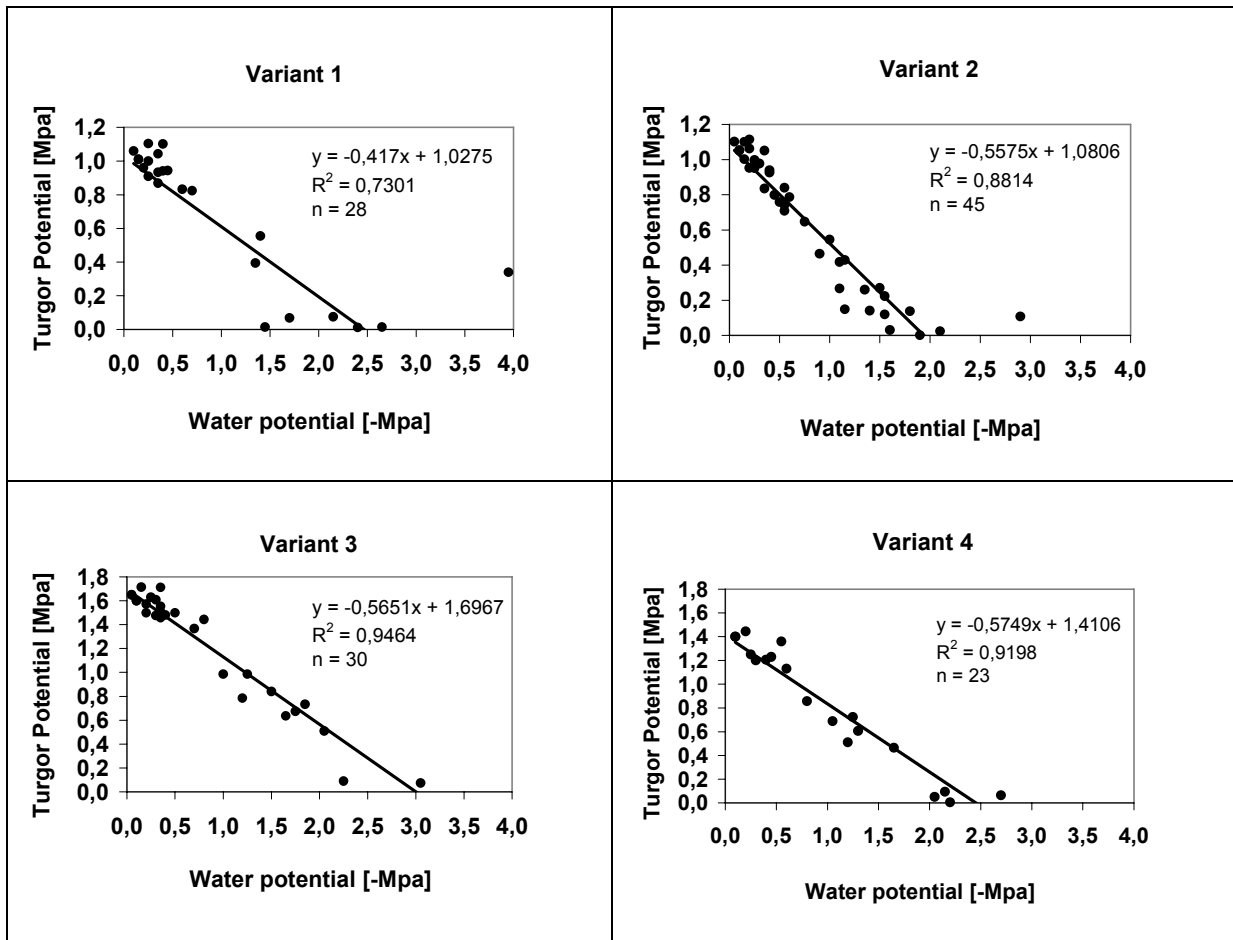

Figure 30: Turgor potential and Water potential of alfalfa variants no 1-4 at harvest 2

The relationship between turgor potential and relative water content (derived from the non-linear part of pressure-volume-curves) gives important information on the plant organ elasticity. At harvest 2, variants 1 and 2 showed a more rapid drop of turgor potential with dehydration and reached the turgor loss point at a relative water content of approximately 0.65 (Figure 31). Variants 3 and 4 showed a more gradual decline of turgor potential with water loss. In variant 3, turgor was lost at a relative water content of 0.54, in variant 4 at 0.58. This means that variant 3 was the most successful one in following the strategy of turgor maintenance under dehydration. At harvest 1, turgor loss point was reached at a relative water content of 0.82 (variant 4), 0.78 (variant 3), 0.75 (variant 2), and 0.70 (variant 1), respectively (data not shown).

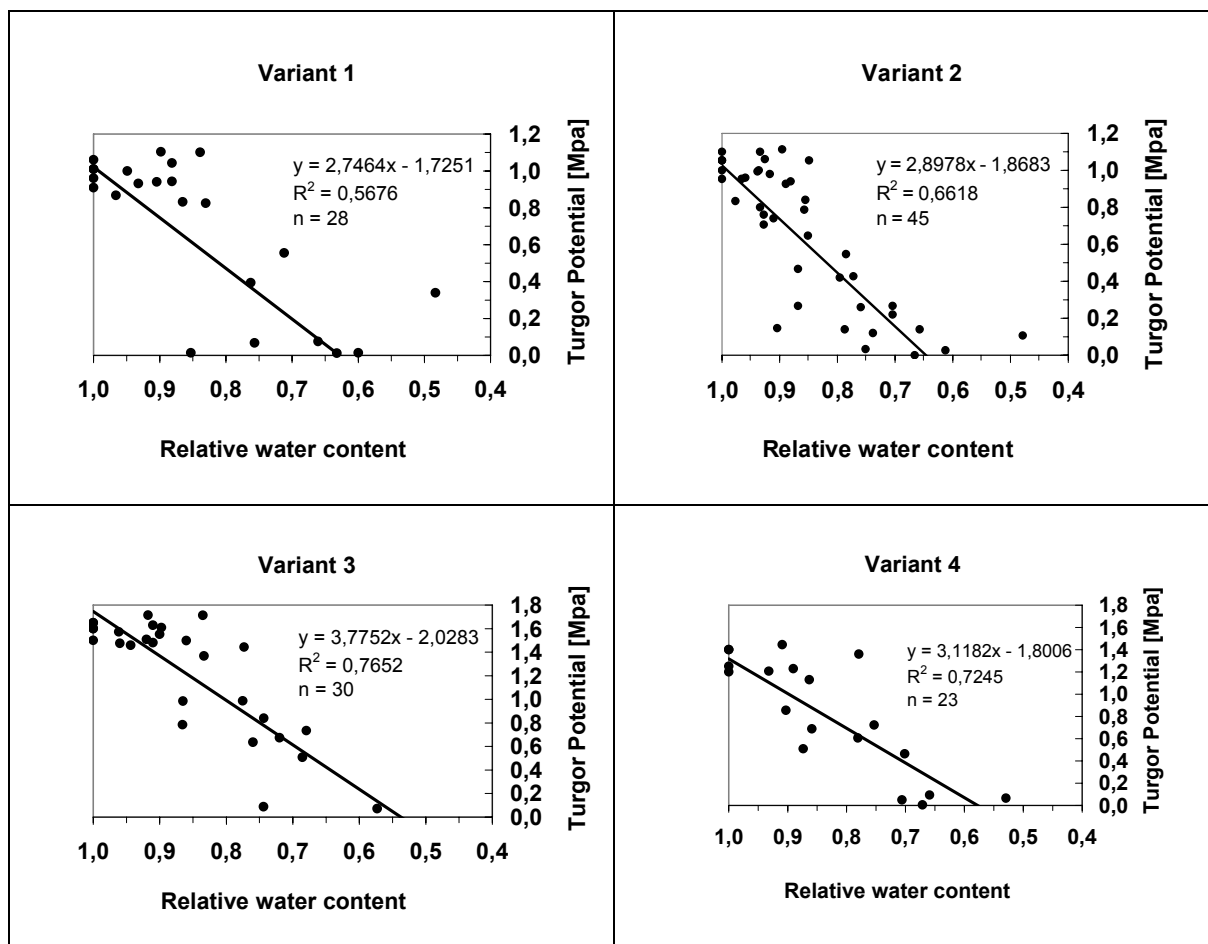

Figure 31: Turgor potential and Relative water content of alfalfa variants no 1-4 at harvest 2

3.9. Comparison of varieties

The tested varieties showed no differences regarding to the main plant parameters (plant height, LAI, weed and pest infestation, above and below ground yield, nitrogen content, nitrogen fixation; see Tables 17-20 in annex) but we found some differences in water use, water use efficiency, and water potential of the plants.

The variety **Vlasta** showed less negative total water potentials at noon at both harvests, a positive turgor potential under field conditions and a higher WUE (according to the $\Delta^{13}\text{C}$ method) at harvest 1, than the other varieties. This could be a hint, that Vlasta, which is originally from Czech Republic, is a variety adapted to dry conditions. Santrucek et al. (2003) reported a dry matter shoot yield for Vlasta of 12.5 t ha^{-1} (average of three years, sum of three harvests), Sisquella et al. (2003) determined an annual dry matter shoot yield of 12.4 t ha^{-1} (mean value of three years) in the dry Ebro Valley in Spain (temperature 15.8°C , annual precipitation 423 mm; trial irrigated with sprinkler every 10-15 days from April to September receiving a total of about 900 mm of water per growing season). Pelikan et al. (2003) determined 25 t ha^{-1} herbage yield and 0.08 t ha^{-1} seed yield (mean value of two years). In the present study the variety Vlasta reached just 4.1 t ha^{-1} annual shoot dry matter yield.

The French variety **Tango** had a higher evapotranspiration at harvest 2 (according to the water balance approach), than the other three varieties. Since the WUE (according to $\Delta^{13}\text{C}$ method) was less than that of variety Vlasta and Sitel at harvest 1, it seemed that Tango is not very efficient in its use of the water resources available at the dry Raasdorf site. Total water potentials reached in the field were near the turgor loss point.

The Flemish variety **Sitel** showed a higher WUE (according to the $\Delta^{13}\text{C}$ method) than Tango at harvest 1. At harvest 2, Sitel was able to maintain positive turgor potential under field conditions due to osmotic and elastic adjustment responses. Zang et al. (2005) reported that the variety Sitel was one of the best 10 tested alfalfa varieties, with relatively high plant height, large leaf/stem ratio and dry matter yield. On the other hand, Xia et al. (2005) found Sitel as one of the least suitable varieties to the dry conditions in the semi-arid region of West China. Bolanos-Aguilar et al. (2002) tested 12 alfalfa varieties in 12 environments for three years and found seed yields ranged from 421 to 1021 kg ha⁻¹. The seed yield of the variety Sitel 803 kg ha⁻¹ was on the average of the 12 varieties. In a field experiment tested 9 alfalfa varieties in West China (Guo et al. 2005), the variety Sitel was low in shoot and root yield due to the dry conditions (mean annual precipitation 380 mm).

The variety **Verko** (originally from Hungary) evaporated less water from April to August than the variety Tango (according to the water balance approach). Similar to Sitel, Verko had also positive turgor potential under field conditions at harvest 2. This could be a hint to some osmotic adjustment under water stress. At the chamber of agriculture in Rheinland-Pfalz in Germany (http://www.ffe.slu.se/Eng/G4/Legsil/legsil11_newallresultsforms.pdf, 2006; 785 mm precipitation, 9.1°C) the variety Verko reached 13.7 t ha⁻¹ total shoot DM yield (average of four years) in variety alfalfa trials. Willner and Jänicke (2004) tested 11 alfalfa varieties under the dry conditions of north-east Germany (Malchow; annual precipitation 530 mm, 9.1°C), among others the variety Verko. The shoot dry matter yield ranged without irrigation from 12 t ha⁻¹ in the first year to 20 t ha⁻¹ in the second year of utilization, the varieties were not significantly different. In the present study, the variety Verko reached just 4.6 t ha⁻¹ annual shoot dry matter yield.

4 Summary

Alfalfa is a perennial forage legume adapted to the dry climatic conditions in Eastern Austria. During the vegetation period of 2005, the differences of four alfalfa varieties with respect to biomass production (above- and below-ground), biological nitrogen fixation, water use and water potential was assessed at two times of alfalfa use. The aim of this study was to find first practical criteria for stockless farmers to choose alfalfa varieties for green manure, adapted to the dry regions of Austria.

Weather in 2005 was characterised by periods of frost without snow cover in winter, sufficient soil water availability in March, and a sum of precipitation during the vegetation period (March-July) of 61 mm below the long-term average. Growth conditions therefore can be regarded as moderately dry. Shoot biomass production ranged from 4.2 to 4.8 t DM ha⁻¹. Below-ground biomass yield varied from 9.8 to 12.0 t DM ha⁻¹ at the second harvest. The mean DM yield ratio above-to-below-ground-biomass ratio) ranged from 0.52 at harvest 1 to 0.22 at harvest 2, the N yield ratio from 0.80 at harvest 1 to 0.32 at harvest 2. The high root biomass probably is due to an occasionally poor water availability within the vegetation period which supported the extension of the root system. Besides, the determination and quantification of alfalfa root biomass is strongly dependent on the used methodology. Therefore, a comparison of the determined alfalfa root biomass with results in the literature is difficult. The biological nitrogen fixation of the alfalfa variants amounted to 280 – 380 kg N ha⁻¹.

From April to August 2005, 302 – 374 mm of water was used by the crops. The water use efficiency was around 660 – 810 L (kg DM)⁻¹. Generally, the tested alfalfa varieties did not differ in their performance during the vegetation period 2005 when only little drought occurred. Less negative water potentials measured at noon, a more positive turgor potential and a greater water use efficiency of the variety **Vlasta** compared to variety **Tango** indicate a better drought adaptation of **Vlasta**. **Tango** seemed to be not very efficient in its use of water resources because of the higher evapotranspiration rate and the lower WUE. The varieties **Sitel** und **Verko** were able to maintain positive turgor potentials which could indicate osmotic adjustment under water stress.

Since breeding and selection is practiced within alfalfa populations, additional research is needed to determine genetic correlations of traits among genotypes or families grown under irrigated and water-stressed conditions. A comparison of the varieties under conditions of more severe drought, e.g. in additional experimental years or by induced water stress in the greenhouse, would be helpful to reveal clear differences between the varieties.

5 References

- Allen, R.G., Pereira, L.S., Raes, D. and Smith, D. (1998): Crop evapotranspiration- Guidelines for computing crop water requirements. FAO irrigation and drainage. Pap.No. 56., Rome.
- Anthes, J. (2005): Beitrag von Ackerbohne (*Vicia faba* L.), Luzerne (*Medicago sativa* L.) und Saatwicke (*Vicia sativa* L.) zur Selbstregelung der N-Zufuhr in leguminosenbasierten Fruchtfolgen. Dissertation Georg-August-Universität Göttingen.
- Antolin, M.C., Yoller, J. und Sanchez-Diaz, M. (1995): Effects of temporary drought on nitrate-fed and nitrogen-fixing alfalfa plants. *Plant Science* 107: 159-165.
- Badaruddin, M. and Meyer, D. W. (1989): Water use by legumes and its effect on soil water status. *Crop Science* 29: 1212-1216.
- Bolanos-Aguilar, E. D., Huyghe, C., Ecalte, C., Hacquet, J. and Julier, B. (2002): Effect of Cultivar and environment on seed yield in alfalfa. *Crop Science* 42: 45-50.
- Bolger, T. P. and Matches, A. G. (1990): Water-Use Efficiency and yield of sainfoin and alfalfa. *Crop Science* 30 (1/2): 143-148.
- Bolton, J. L., Goplen, B. P. and Baenzinger, H. (1972): World distribution and historical developments. In: Hansen, C. H. (Ed.), *Alfalfa Science and Technology*, American Society of Agronomy, Madison, pp. 1-34.
- Brown, P. W. and Tanner, C. B. (1981): Alfalfa water potential measurement: A comparison of the pressure chamber and leaf dew point hygrometer. *Crop Science* 21: 240-244.
- Carter, P. R. and Sheaffer, C. C. (1983a): Alfalfa response to soil water deficits. I. Growth, forage quality yield, water use, and water-use efficiency. *Crop Science* 23: 669-675.
- Carter, P. R. and Sheaffer, C. C. (1983b): Alfalfa response of alfalfa to soil water deficits. II. Plant water potential, leaf conductance, and canopy temperature relationships. *Crop Science* 23: 676-680.
- Craig, H. (1957): Isotopic standards for carbon and oxygen and correlation factors for mass-spectrometric analysis of carbon dioxide. *Geochim. Acta* 12: 133-149.
- Ehlers, W. (1996): *Wasser in Boden und Pflanze*. Verlag Eugen Ulmer, Stuttgart.
- Ehlers, W. and Goss, M. (2003): *Water Dynamics in Plant Production*. CAB International, Wallingford, UK.
- Farquhar, G. D., Ehleringer, J. R. und Hubick, K. T. (1989): Carbon isotope discrimination and photosynthesis. *Annu. Rev. Plant Physiol. Plant Mol. Biol.* 40: 503-537.
- Freyer B, Friedel JK, Vogl C, Pietsch G, and Ehrmann O. (2000): Monitoring von Bodenkennwerten in der Umstellung auf Ökologischen Landbau im Trockengebiet Ostösterreichs. Institut für Ökologischen Landbau, Universität für Bodenkultur Wien. 1-75. Wien. Abschlußbericht Forschungsprojekt Nr. 1170.
- Girousse, C., Bournoville, R. and Bonnemain, J. L. (1996): Water deficit-induced changes in concentration in praline and some other amino acids in the phloem sap of alfalfa. *Plant Physiol.* 111: 109-113.
- Guo Z. G., Liu, H. X., Wang, S. M., Tian, F. P. and Cheng, G. D. (2005): Biomass, persistence and drought resistance of nine lucerne varieties in the dry environment of west China. *Australian Journal of Experimental Agriculture* 45: 59-64.
- Hendry, G. W. (1923): Alfalfa in history. *Journal of the American Society of Agronomy* 15: 171-176.

- Hirth, J. R., Haines, P. J., Ridley, A. M. and Wilson, K. F. (2001): Lucerne in crop rotations on the Riverine Plains 2. Biomass and grain yields, water use efficiency, soil nitrogen, and profitability. *Australian Journal of Agricultural Research* 52: 279-293.
- Hrbek, R. (2005). Auswirkungen variierter Nutzungstermine auf den Ertrag, die Stickstofffixierleistung und auf die Beikrautentwicklung in Luzernebeständen im pannonischen Klimaraum Österreichs. Diplomarbeit, Universität für Bodenkultur, Wien.
- Johnson, R. C. and Bassett, L. B. (1991): Carbon isotope discrimination and water use efficiency in alfalfa germplasm. *Crop Science* 31: 157-162.
- Johnson, R. C. and Tieszen (1994): Variation for water-use efficiency in alfalfa germplasm. *Crop Science* 34: 452-458.
- Jung, R. (2003): Stickstoff-Fixierleistung von Luzerne (*Medicago sativa* L.) Rotklee (*Trifolium pratense* L.) und Persischem Klee (*Trifolium resupinatum* L.) in Reinsaat und Gemenge mit Poaceen. Experimentelle Grundlagen und Kalkulationsverfahren zur Ermittlung der Stickstoff-Flächenbilanz. Dissertation Georg-August-Universität Göttingen.
- Kikuta, S. B. and Richter, H. (1992): A simplified pressure-volume method for the estimation of osmotic adjustment with the pressure chamber. *Die Bodenkultur* 43: 307-318.
- Kikuta, S. B. (2003): Skript zur Vorlesung: Methoden zur Untersuchung der Stressresistenz von Pflanzen. Universität für Bodenkultur, Wien.
- Kemper, W. D. and Amemiya, M. (1957): Alfalfa growth as affected by aeration and soil moisture stress under flood irrigation. *Soil Science Soc. Am. Proc.* 21: 657-660.
- Lahrer, F., Lepout, L., Petrivalsky, M. and Chappart, M. (1993): Effectors for the osmoinduced praline response in higher plants. *Plant Physiol. Biochem.* 31: 911-922.
- Larcher, W. (1994): Ökophysiologie der Pflanzen. 5. Auflage, Ulmer Verlag, Stuttgart.
- Luis, D., Irigoyen, J. J. And Sanchez-Diaz, M. (1999): Elevated CO₂ enhances plant growth in droughted N₂-fixing alfalfa without improving water status. *Physiologia Plantarum* 107: 84-89.
- Ljungkull, J. E. (1982): An experimental investigation of Evapotranspiration estimation methods. M. S. Thesis, Univ. of Minnesota.
- McAuliffe, C., Chamblee, D.S., Uribe-Arango, H. and Woodhouse, W.W. (1958): Influence of inorganic nitrogen on nitrogen fixation by legumes as revealed by 15N. *Agronomy Journal* 50: 334-337.
- Passioura, J.B. 1994. The yield of crops in relation to drought. pp. 343-359 In: K.J. Boote et al. (ed.) *Physiology and Determination of Crop Yield*. ASA, CSSA, and SSSA, Madison, WI.
- Pelikan, J., Gottwaldova, P. and Vymyslicky, T. (2003): Evaluation of the alfalfa assortment under the conditions of the Czech Republic. *Czech. J. Genet. Plant Breed.* 39 (Special Issue): 228-231.
- Peoples, M.B., Bell, M.J. and Bushby, H.V.A. (1992): Effect of rotation and inoculation with *Bradyrhizobium* on nitrogen fixation and yield of peanut (*Arachis hypogaea* L., cv Virginia Bunch). *Aust. J. Agric. Res.* 43: 595 – 607.
- Pietsch, G. (2004): N₂-Fixierungsleistung und Wasserverbrauch von Futterleguminosen im Ökologischen Landbau unter den klimatischen Bedingungen der pannonischen Region Österreichs. Dissertation Universität für Bodenkultur, Wien.
- Pietsch, G., Hrbek, R. and Friedel, J. K. (2006a): The effects of different mulching dates on yield and nitrogen fixation of green manure Lucerne. Submitted.

- Pietsch, G., Friedel, J. K., Starz, W., Kikuta, S., Loiskandl, W., Strauss-Sieberth, A. und Freyer, B. (2006b): Biological nitrogen fixation of different legume species under water stress - BIOfix – Project. Final report. Auftraggeber: Bundesministerium für Bildung, Wissenschaft und Kultur, Wien.
- Ray, I. M., Townsend, M. S. and Henning, J. A. (1998): Variation for yield, water-use efficiency, and canopy morphology among nine alfalfa germplasms. *Crop Science* 38: 1386-1390.
- Rinnofner, T., Farthofer, R., Friedel, J. K., Pietsch, G., Strauss-Sieberth, A., Loiskandl, W. und Freyer, B. (2005): Stickstoffaufnahme und Biomasseertrag von Zwischenfrüchten und deren Auswirkungen auf Ertrag und Qualität der Folgekultur und Nitratgehalt in der Bodenlösung unter den Bedingungen des Ökologischen Landbaus im pannonischen Klimagebiet. Endbericht Projekt Nr. 1246, Bundesministerium für Land- und Forstwirtschaft, Umwelt und Wasserwirtschaft, Wien.
- Santrucek, J., Svobodova, M. and Hlavickova, D. (2003): The influence of stands cultivation on persistency of different cultivars of *Medicago sativa* L. *Plant, Soil and Environment* 49 (11): 499-504.
- Sheaffer, C. C., Tanner, C. B. and Kirkham, M. B. (1988): Alfalfa water relations and irrigation. In: A. A. Hanson et al. (ed.) *Alfalfa and alfalfa improvement*. *Agronomy* 29: 373-409.
- Shearer, G. und Kohl, D. H. (1993): Natural abundance of ^{15}N : fractional contribution of two sources to a common sink and use of isotope discrimination. In: *Nitrogen isotope techniques*. R. Knowles & T.H. Blackburn. Academic Press, San Diego: 89-125.
- Sisquella, M., Lloveras, J., Lopez, A., Betbese, J. A., Baga, M. and Lopez, A. (2003): European Varieties of Alfalfa for the irrigated areas of the Ebro Valley (Spain). *Czech. J. Genet. Plant Breed.* 39 (Special Issue): 241-243.
- Slavik, B. (1974): *Methods of Studying Plant Water Relations*. Chapman and Hall Ltd: London, 449 p.
- Stülpnagel, R. (1982): Schätzung der von Ackerbohnen symbiotisch fixierten Stickstoffmenge im Feldversuch mit der erweiterten Differenzmethode. *Zeitschr. Acker- und Pflanzenbau* 150: 446-458.
- Scholander, P. F., Hammel, H.T., Bradstreet, E.D. and E.A. Hemmingsen (1965): Sap pressure in vascular plants, *Science* 148: 339-346.
- Tanner, C. B. and Pelton, W. L. (1960): Potential Evapotranspiration estimates by the approximate energy balance method of Penman. *J. Geophy. Res.* 65: 3391-3413.
- Taylor, S. A. (1952): Use of mean soil moisture tension to evaluate the effect of soil moisture on crop yields. *Soil Sci.* 74: 217-226.
- Willner, E. and Jänicke, H. (2004): Zu ausgewählten Eigenschaften der Luzerne unter nordostdeutschen Standortbedingungen. In: 45. Fachtagung des DLG-Ausschusses „Gräser, Klee und Zwischenfrüchte“: Züchtungsperspektiven und Saatgutproduktion bei Gräsern, Klee und Zwischenfrüchten. Fachtagung vom 30.11.-1.12.2004 in Fulda: 87-92.
- Xia, L. H., Gang, G. Z., Ming, W. S., He, Z. Z. and Rong, W. Y. (2005): A new procedure for evaluating lucerne genotypes for semi-arid land in west China. *New Zealand Journal of agricultural research* 48 (1): 109-116.
- Zang, W. M., Wang, C. Z. and Yang, Y. X. (2005): Production performance of different lucerne varieties in China. *New Zealand Journal of agricultural research* 48 (4): 481-488.

6 Annex

Table 17: Specific plant parameters of alfalfa variants no 1-4 at harvests 1 and 2

Harvest	Specific plant parameters	Unit	Variant	Mean	Stddev
1	Plant density (spring)	plants m ²	1	282,8 ^a	25,8
			2	283,9 ^a	24,4
			3	270,8 ^a	23,1
			4	278,1 ^a	25,5
	Plant density (summer)	plants m ²	1	132,3 ^a	10,4
			2	132,8 ^a	21,3
			3	129,7 ^a	12,8
			4	119,8 ^a	15,7
	Pest infestation spring	Larva of pea and bean weevil	1	3,5 ^a	0,6
			2	3,5 ^a	0,6
			3	3,8 ^a	1,0
			4	3,5 ^a	1,0
	Weed infestation spring ¹	points	1	2,0 ^a	0,8
			2	1,8 ^a	0,5
			3	1,8 ^a	1,0
			4	1,5 ^a	1,0
Gabs in plant population	%	1	12,5 ^a	12,6	
		2	7,5 ^a	9,6	
		3	15,0 ^a	12,9	
		4	20,0 ^a	28,3	
Development at harvest ²	points	1	64 ^a	2	
		2	65 ^a	1	
		3	65 ^a	0	
		4	64 ^a	2	
Leaf area index		1	1,57 ^a	0,13	
		2	1,96 ^a	0,42	
		3	1,84 ^a	0,18	
		4	1,73 ^a	0,12	
Leaf steam proportion	proportion	1	1,3 ^a	0,2	
		2	1,4 ^a	0,3	
		3	1,3 ^a	0,2	
		4	1,4 ^a	0,5	
2	Weed infestation summer ¹	points	1	1,3 ^a	0,5
			2	1,3 ^a	0,5
			3	1,3 ^a	0,5
			4	1,5 ^a	0,6
	Gabs in plant population	%	1	22,5 ^a	9,6
			2	17,5 ^a	5,0
			3	22,5 ^a	9,6
			4	22,5 ^a	12,6
	Development at harvest ²	points	1	63 ^a	1
			2	64 ^a	2
			3	64 ^a	2
			4	63 ^a	2
	Leaf area index		1	1,83 ^a	0,44
			2	2,07 ^a	0,40
			3	1,87 ^a	0,49
			4	2,14 ^a	0,59

Leaf-stem-proportion	proportion	1	1,2 ^a	0,1
		2	1,2 ^a	0,1
		3	1,2 ^a	0,2
		4	1,1 ^a	0,2

¹ Weed infestation: 1 = 0-10 %, 2 = 11-50 %, 3 = 51-80 % and 4 = >80 % weed infestation of the total area

² Development at harvest: 61 = 10% blossom, 62 = 30% blossom, 63 = 50% blossom, 65 = 70% blossom, 67 = 50% overblown and 69 = 100% overblown. Stddev: standard deviation; means with same letters are not significant different; Tukey-Test p > 0.05

Table 18: Dry matter yield of shoot, stubbles and roots of alfalfa variants no 1-4 at harvests 1 and 2

Harvest	Dry matter yield (DM)	Unit	Variant	Mean	Stddev
1	Shoot	kg ha ⁻¹	1	2554 ^a	716
			2	2911 ^a	676
			3	3013 ^a	495
			4	2828 ^a	666
	Stubbles	kg ha ⁻¹	1	664 ^a	60
			2	697 ^a	191
			3	610 ^a	79
			4	573 ^a	196
	Roots (0-30 cm)	kg ha ⁻¹	1	5115 ^a	1285
			2	7771 ^a	2264
			3	5157 ^a	1142
			4	5603 ^a	2548
	Roots (30-60 cm)	kg ha ⁻¹	1	774 ^a	284
			2	986 ^a	227
			3	832 ^a	259
			4	1024 ^a	346
Roots (0-60 cm)	kg ha ⁻¹	1	5889 ^a	1459	
		2	8757 ^a	2454	
		3	5990 ^a	1312	
		4	6627 ^a	2664	
2	Shoot	kg ha ⁻¹	1	1603 ^a	253
			2	1773 ^a	355
			3	1827 ^a	492
			4	1737 ^a	356
	Stubbles	kg ha ⁻¹	1	657 ^a	99
			2	676 ^a	113
			3	630 ^a	68
			4	681 ^a	106
	Roots (0-30 cm)	kg ha ⁻¹	1	10267 ^a	646
			2	9776 ^a	3101
			3	10829 ^a	4112
			4	8810 ^a	1254
	Roots (30-60 cm)	kg ha ⁻¹	1	951 ^a	606
			2	1464 ^a	569
			3	1206 ^a	332
			4	963 ^a	479
Roots (0-60 cm)	kg ha ⁻¹	1	11218 ^a	976	
		2	11240 ^a	3105	
		3	12036 ^a	4431	
		4	9773 ^a	1688	

Stddev: standard deviation; means with same letters are not significant different; Tukey-Test p > 0.05

Table 19: Nitrogen content and Nitrogen yield of shoot, stubbles, roots, leaves and stem of alfalfa variants no 1-4 at harvests 1 and 2

Harvest	Nitrogen content/yield	Unit	Variant	Mean	Stddev
1	Shoot	%	1	3,2 ^a	0,0
			2	3,6 ^a	0,3
			3	3,3 ^a	0,3
			4	3,5 ^a	0,3
	Shoot	kg ha ⁻¹	1	81,6 ^a	22,3
			2	103,2 ^a	21,8
			3	99,2 ^a	12,0
			4	99,1 ^a	19,0
	Stubbles	%	1	2,4 ^a	0,1
			2	2,2 ^a	0,1
			3	2,3 ^a	0,1
			4	2,4 ^a	0,2
	Stubbles	kg ha ⁻¹	1	16,2 ^a	1,6
			2	15,6 ^a	4,4
			3	14,3 ^a	1,8
			4	13,9 ^a	5,6
	Roots (0-30 cm)	%	1	2,0 ^a	0,1
			2	2,1 ^a	0,3
			3	2,1 ^a	0,1
			4	2,1 ^a	0,0
Roots (0-30 cm)	kg ha ⁻¹	1	101,2 ^a	21,7	
		2	165,0 ^a	70,8	
		3	109,8 ^a	27,5	
		4	120,6 ^a	55,7	
Roots (30-60 cm)	%	1	1,9 ^a	0,2	
		2	1,9 ^a	0,3	
		3	1,8 ^a	0,3	
		4	2,0 ^a	0,2	
Roots (30-60 cm)	kg ha ⁻¹	1	15,3 ^a	6,6	
		2	18,4 ^a	5,0	
		3	15,7 ^a	6,2	
		4	19,9 ^a	6,3	
Leaves	%	1	3,9 ^a	0,3	
		2	3,9 ^a	0,2	
		3	4,0 ^a	0,6	
		4	3,8 ^a	0,2	
Stem	%	1	1,6 ^a	0,2	
		2	1,7 ^a	0,2	
		3	1,7 ^a	0,2	
		4	1,7 ^a	0,2	
2	Shoot	%	1	3,8 ^a	0,4
			2	3,5 ^a	0,4
			3	3,4 ^a	0,6
			4	3,5 ^a	0,6
	Shoot	kg ha ⁻¹	1	60,0 ^a	8,5
			2	62,4 ^a	12,0
			3	61,1 ^a	8,9
			4	62,9 ^a	22,6
	Stubbles	%	1	2,2 ^a	0,1
2			2,2 ^a	0,2	

			3	2,0 ^a	0,1
			4	2,1 ^a	0,2
Stubbles	kg ha ⁻¹		1	14,3 ^a	2,0
			2	14,7 ^a	3,7
			3	12,6 ^a	1,4
			4	14,0 ^a	2,3
Roots (0-30 cm)	%		1	2,2 ^a	0,1
			2	2,1 ^a	0,0
			3	2,1 ^a	0,1
			4	2,2 ^a	0,3
Roots (0-30 cm)	kg ha ⁻¹		1	224,7 ^a	21,9
			2	206,7 ^a	64,1
			3	235,5 ^a	100,9
			4	196,5 ^a	54,2
Root (30-60 cm)	%		1	2,0 ^a	0,1
			2	2,1 ^a	0,1
			3	2,1 ^a	0,1
			4	2,0 ^a	0,2
Roots (30-60 cm)	kg ha ⁻¹		1	18,6 ^a	11,2
			2	30,3 ^a	11,9
			3	24,8 ^a	7,1
			4	19,8 ^a	11,8
Leaves	%		1	4,4 ^a	0,3
			2	4,4 ^a	0,4
			3	4,4 ^a	0,5
			4	4,4 ^a	0,5
Stem	%		1	1,6 ^a	0,1
			2	1,6 ^a	0,1
			3	1,7 ^a	0,0
			4	1,5 ^a	0,2

Stddev: standard deviation; means with same letters are not significant different; Tukey-Test $p > 0.05$

Table 20: Nitrogen fixation and Nitrogen derived from the atmosphere of alfalfa variants no 1-4 at harvests 1 and 2

Harvest	Nitrogen fixation	Unit	Variant	Mean	Stddev
1	Total N-fixation (N _{fix})	kg ha ⁻¹	1	131,6 ^a	50,3
			2	209,9 ^a	66,9
			3	151,5 ^a	32,3
			4	158,3 ^a	82,1
	Nitrogen derived from the atmosphere (N _{dfa})	%	1	54,7 ^a	9,7
			2	68,4 ^a	1,4
			3	53,0 ^a	18,7
			4	65,0 ^a	8,8
2	Total N-fixation (N _{fix})	kg ha ⁻¹	1	149,6 ^a	46,7
			2	170,7 ^a	61,7
			3	219,3 ^a	91,3
			4	137,4 ^a	40,5
	Nitrogen derived from the atmosphere (N _{dfa})	%	1	55,8 ^a	16,5
			2	76,2 ^a	7,4
			3	59,1 ^a	10,3
			4	63,9 ^a	10,1

Stddev: standard deviation; means with same letters are not significant different; Tukey-Test $p > 0.05$

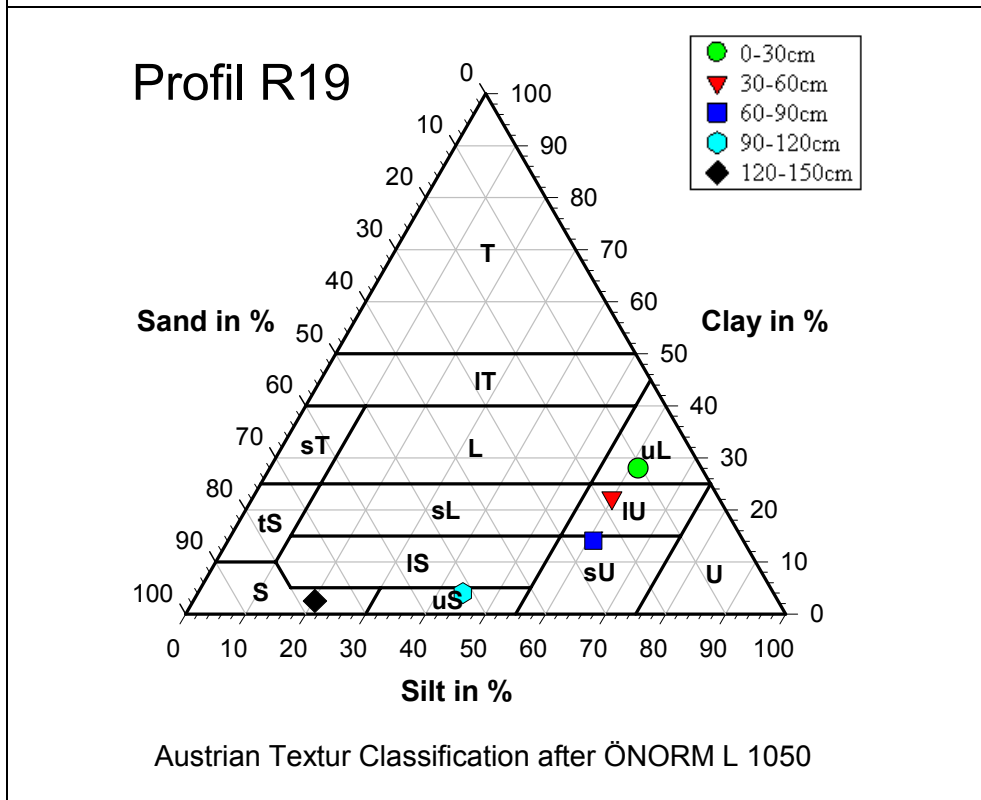
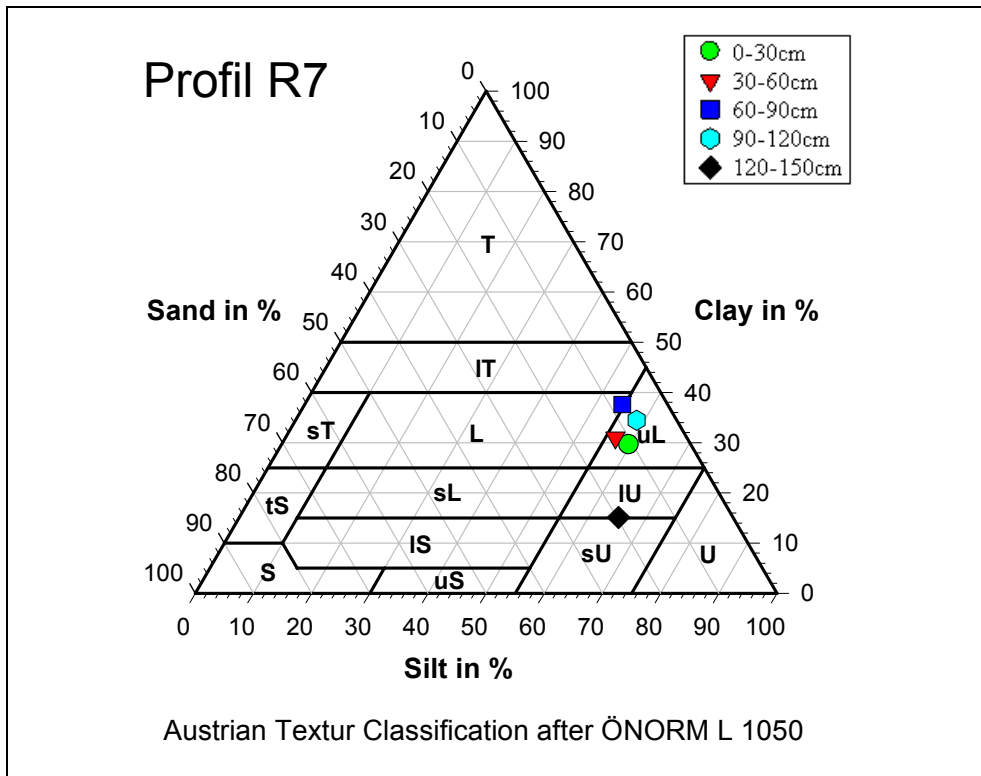
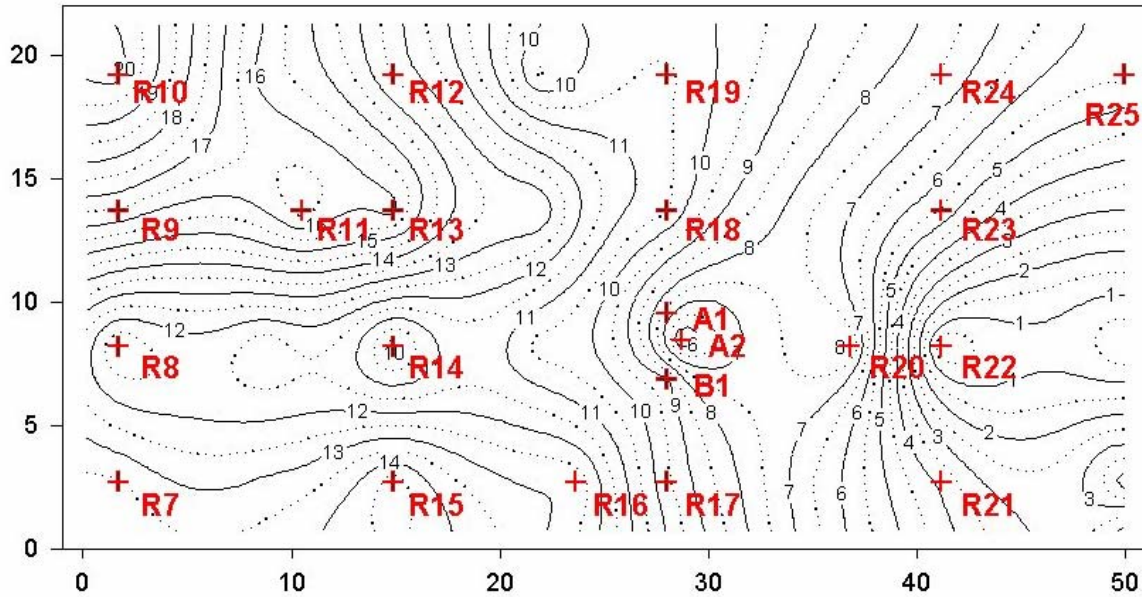

Figure 32: Texture of the soil profile at measuring tube R7 (plot 1) and R19 (plot 12), representing a mighty and shallow Loess layer, resp.



Legend: Distances along the axes: m, altitude level: cm. R7 ... R 25: Soil Diviner tubes for measuring soil water content. A1 ... A2: continuous measuring device.

Figure 33: Altitude model of the experimental site

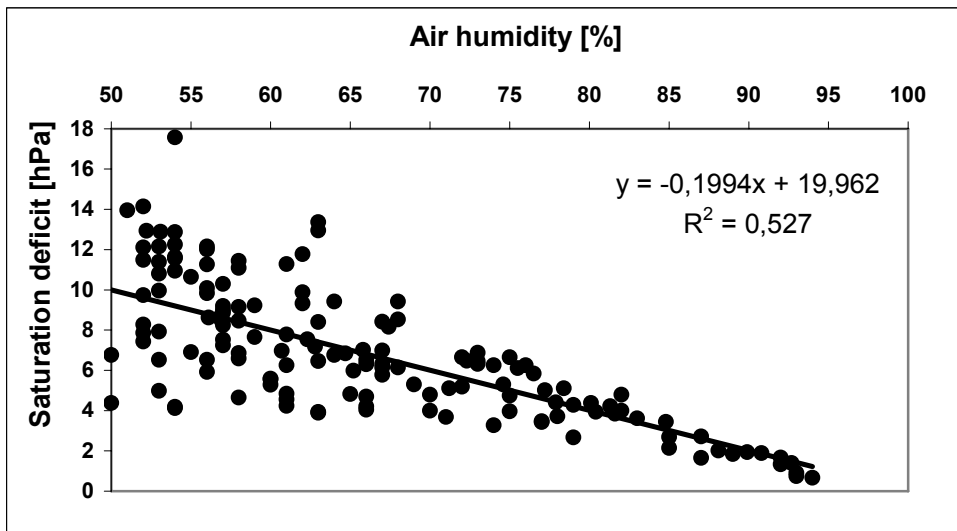

Figure 34: Saturation deficit and air humidity at the site "Raasdorf" from 1.4.-31.8.2005

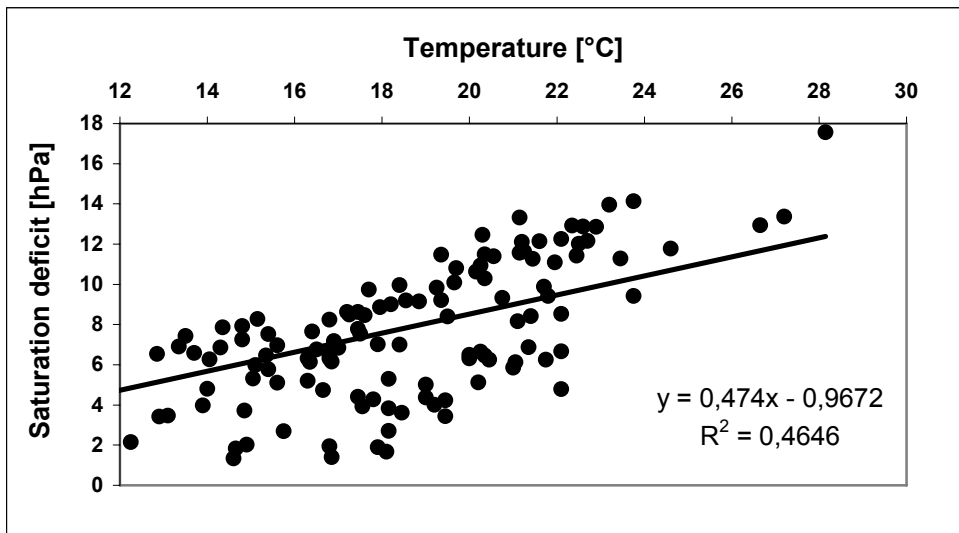

Figure 35: Saturation deficit and temperature at the site "Raasdorf" from 1.4.-31.8.2005